

MBA

2024.3

Levelling Mounts

Male Threaded, Female Socket, Many styles and colours.



Socket Type
Pages 3 - 7

Studded Type
Pages 8 - 33

Selection of leveling mounts listed by thread size. This catalogue is a quick reference guide to help you find parts quickly. Enter a part number into the search box on the website to obtain full details.

To find and order parts online, simply enter the part number from this catalogue into the search box on any web page.

Basic Diagrams: Note, many part numbers in this catalogue will vary slightly from the diagrams below. Please use these diagrams as a basic guide and double check the part numbers online for the correct corresponding diagrams.

Socket Type

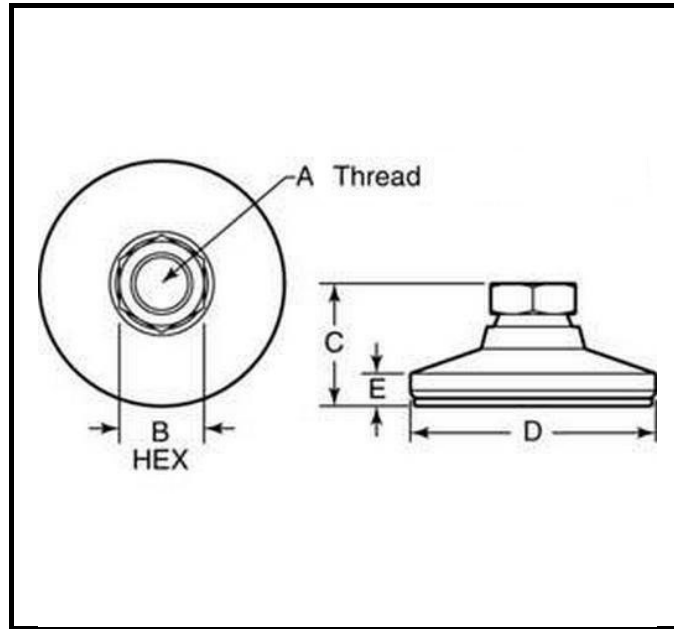



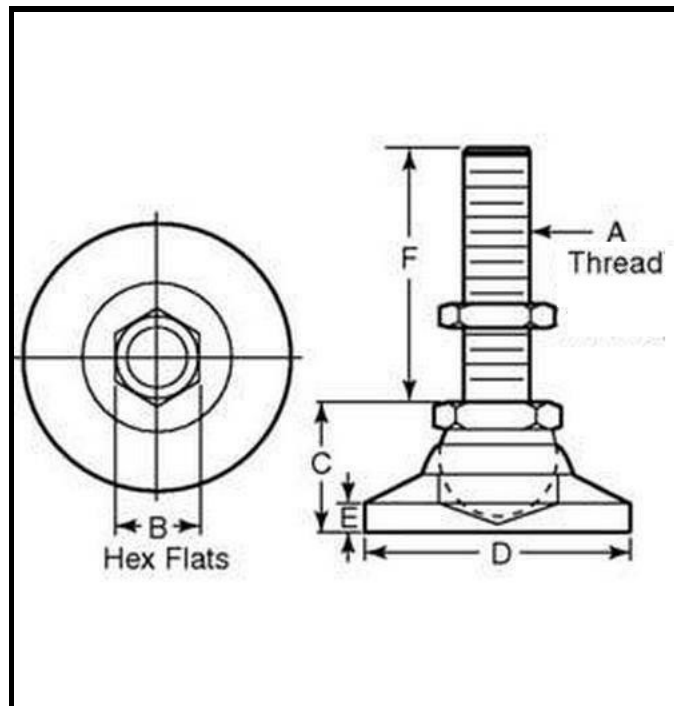

Studded type



Socket Type



Thread Size (A)	Base Diameter (D) mm (in.)	Min.Thread Depth mm (in.)	Load Rating Kg	Part Number
Thread Size (A) 10-32 UNF (4.76 mm)				
10-32 UNF (4.76 mm)	19.10	4.30	70.0	MSF-048F-S3AP Mounts - Levelling - Socket - 303 Stainless - Swivel - Acetal Base
10-32 UNF (4.76 mm)	19.10	4.30	70.0	MSF-048F-CGCAP Mounts - Levelling - Socket - Gold Chromate - Swivel - Acetal Base
10-32 UNF (4.76 mm)	19.10	4.30	240.0	MSF-048F-S6RP Mounts - Levelling - Socket - 316 Stainless - Swivel - Rubber Padded
10-32 UNF (4.76 mm)	19.10	4.30	240.0	MSF-048F-CGCRP Mounts - Levelling - Socket - Gold Chromate - Swivel - Rubber Padded
10-32 UNF (4.76 mm)	19.10	4.30	270.0	MSF-048F-CBC Mounts - Levelling - Socket - Black Chromate - Swivel
10-32 UNF (4.76 mm)	19.10	4.30	315.0	MSF-048F-S3 Mounts - Levelling - Socket - 303 Stainless - Swivel
10-32 UNF (4.76 mm)	19.10	4.30	315.0	MSF-048F-CCC Mounts - Levelling - Socket - Clear Chromate - Swivel
10-32 UNF (4.76 mm)	19.10	4.30	315.0	MSF-048F-CGC Mounts - Levelling - Socket - Gold Chromate - Swivel
10-32 UNF (4.76 mm)	19.10	4.30	315.0	MSF-048F-CNP Mounts - Levelling - Socket - Nickel Plated - Swivel
10-32 UNF (4.76 mm)	19.10	4.30	240.0	MSF-048F-CBCRP Mounts - Levelling - Socket - Black Chromate - Swivel - Rubber Padded
10-32 UNF (4.76 mm)	19.10	4.30	240.0	MSF-048F-CCCRP Mounts - Levelling - Socket - Clear Chromate - Swivel - Rubber Padded
Thread Size (A) M6x1 (6 mm)				
M6x1 (6 mm)	19.00	4.00	315.0	MSF-060M-S3-040 Mounts - Levelling - Socket - 303 Stainless - Swivel
M6x1 (6 mm)	19.00	4.00	315.0	MSF-060M-CNP Mounts - Levelling - Socket - Nickel Plated - Swivel
M6x1 (6 mm)	19.10	5.80	240.0	MSF-060M-S3-058 Mounts - Levelling - Socket - 303 Stainless - Swivel
M6x1 (6 mm)	19.10	5.80	315.0	MSF-060M-CGC Mounts - Levelling - Socket - Gold Chromate - Swivel
Thread Size (A) 1/4-20 UNC (6.35 mm)				
1/4-20 UNC (6.35 mm)	25.40	7.90	90.0	MSF-064C-S3AP Mounts - Levelling - Socket - 303 Stainless - Swivel - Acetal Base
1/4-20 UNC (6.35 mm)	25.40	7.90	90.0	MSF-064C-CGCAP Mounts - Levelling - Socket - Gold Chromate - Swivel - Acetal Base
1/4-20 UNC (6.35 mm)	25.40	7.90	315.0	MSF-064C-CBC Mounts - Levelling - Socket - Black Chromate - Swivel
1/4-20 UNC (6.35 mm)	25.40	7.90	360.0	MSF-064C-CGCRP Mounts - Levelling - Socket - Gold Chromate - Swivel - Rubber Padded
1/4-20 UNC (6.35 mm)	25.40	7.90	450.0	MSF-064C-S3RP Mounts - Levelling - Socket - 303 Stainless - Swivel - Rubber Padded
1/4-20 UNC (6.35 mm)	25.40	7.90	490.0	MSF-064C-CCC Mounts - Levelling - Socket - Clear Chromate - Swivel
1/4-20 UNC (6.35 mm)	25.40	7.90	500.0	MSF-064C-S3 Mounts - Levelling - Socket - 303 Stainless - Swivel
1/4-20 UNC (6.35 mm)	25.40	-	500.0	MSF-064C-CGC Mounts - Levelling - Socket - Gold Chromate - Swivel
1/4-20 UNC (6.35 mm)	25.40	7.90	360.0	MSF-064C-CBCRP Mounts - Levelling - Socket - Black Chromate - Swivel - Rubber Padded
1/4-20 UNC (6.35 mm)	25.40	7.90	360.0	MSF-064C-CCCRP Mounts - Levelling - Socket - Clear Chromate - Swivel - Rubber Padded
Thread Size (A) M8x1.25 (8 mm)				
M8x1.25 (8 mm)	25.00	8.00	450.0	MSF-080M-CNP Mounts - Levelling - Socket - Nickel Plated - Swivel
M8x1.25 (8 mm)	25.00	8.00	340.0	MSF-080M-S3RP Mounts - Levelling - Socket - 303 Stainless - Swivel - Rubber Padded



 Usually stocked or Short Delivery
 ** Available while stocks last **

 Long Delivery or Large Minimum Quantities
 Not in current production

Socket Type

Thread Size (A)	Base Diameter (D) mm (in.)	Min.Thread Depth mm (in.)	Load Rating Kg	Part Number
Thread Size (A) M8x1.25 (8 mm)				
M8x1.25 (8 mm)	25.40	7.90	500.0	MSF-080M-CGC Mounts - Levelling - Socket - Gold Chromate - Swivel
M8x1.25 (8 mm)	25.40	7.90	540.0	MSF-080M-S3 Mounts - Levelling - Socket - 303 Stainless - Swivel
Thread Size (A) 3/8-16 UNC (9.53 mm)				
3/8-16 UNC (9.53 mm)	31.80	9.70	140.0	MSF-095C-S3AP Mounts - Levelling - Socket - 303 Stainless - Swivel - Acetal Base
3/8-16 UNC (9.53 mm)	31.80	9.70	140.0	MSF-095C-CGCAP Mounts - Levelling - Socket - Gold Chromate - Swivel - Acetal Base
3/8-16 UNC (9.53 mm)	31.80	9.70	1270.0	MSF-095C-S3RP Mounts - Levelling - Socket - 303 Stainless - Swivel - Rubber Padded
3/8-24 UNF (9.53 mm)	31.80	9.70	1270.0	MSF-095F-CGC Mounts - Levelling - Socket - Gold Chromate - Swivel
3/8-16 UNC (9.53 mm)	31.80	9.70	1270.0	MSF-095C-CGCRP Mounts - Levelling - Socket - Gold Chromate - Swivel - Rubber Padded
3/8-16 UNC (9.53 mm)	31.80	9.70	1700.0	MSF-095C-CBC Mounts - Levelling - Socket - Black Chromate - Swivel
3/8-16 UNC (9.53 mm)	31.80	9.70	1700.0	MSF-095C-CCC Mounts - Levelling - Socket - Clear Chromate - Swivel
3/8-16 UNC (9.53 mm)	31.80	9.70	1700.0	MSF-095C-CGC Mounts - Levelling - Socket - Gold Chromate - Swivel
3/8-16 UNC (9.53 mm)	31.80	9.70	1700.0	MSF-095C-CNP Mounts - Levelling - Socket - Nickel Plated - Swivel
3/8-16 UNC (9.53 mm)	31.80	9.70	1270.0	MSF-095C-CBCRP Mounts - Levelling - Socket - Black Chromate - Swivel - Rubber Padded
3/8-16 UNC (9.53 mm)	31.80	9.70	1270.0	MSF-095C-CCCRP Mounts - Levelling - Socket - Clear Chromate - Swivel - Rubber Padded
Thread Size (A) M10x1.5 (10 mm)				
M10x1.5 (10 mm)	32.00	9.60	1700.0	MSF-100M-CBC Mounts - Levelling - Socket - Black Chromate - Swivel
M10x1.5 (10 mm)	32.00	9.70	1700.0	MSF-100M-S3 Mounts - Levelling - Socket - 303 Stainless - Swivel
M10x1.5 (10 mm)	32.00	9.70	1700.0	MSF-100M-CGC Mounts - Levelling - Socket - Gold Chromate - Swivel
M10x1.5 (10 mm)	32.00	10.00	1740.0	MSF-100M-CNP Mounts - Levelling - Socket - Nickel Plated - Swivel
M10x1.5 (10 mm)	32.00	9.60	1270.0	MSF-100M-CGCRP Mounts - Levelling - Socket - Gold Chromate - Swivel - Rubber Padded
M10x1.5 (10 mm)	32.00	10.00	1270.0	MSF-100M-S3RP Mounts - Levelling - Socket - 303 Stainless - Swivel - Rubber Padded
Thread Size (A) M12x1.75 (12 mm)				
M12x1.75 (12 mm)	48.00	11.00	2250.0	MSF-120M-CNP Mounts - Levelling - Socket - Nickel Plated - Swivel
M12x1.75 (12 mm)	48.00	11.20	1750.0	MSF-120M-S3 Mounts - Levelling - Socket - 303 Stainless - Swivel
M12x1.75 (12 mm)	48.00	11.20	2270.0	MSF-120M-CBC Mounts - Levelling - Socket - Black Chromate - Swivel
M12x1.75 (12 mm)	48.00	11.20	2270.0	MSF-120M-CGC-048 Mounts - Levelling - Socket - Gold Chromate - Swivel
M12x1.75 (12 mm)	48.00	11.00	1700.0	MSF-120M-CNPRP Mounts - Levelling - Socket - Nickel Plated - Swivel - Rubber Padded
M12x1.75 (12 mm)	48.00	11.20	1700.0	MSF-120M-CGCRP Mounts - Levelling - Socket - Gold Chromate - Swivel - Rubber Padded
Thread Size (A) 1/2-13 UNC (12.7 mm)				
1/2-13 UNC (12.7 mm)	47.60	11.20	315.0	MSF-127C-S3AP Mounts - Levelling - Socket - 303 Stainless - Swivel - Acetal Base

 Usually stocked or Short Delivery
 ** Available while stocks last **

 Long Delivery or Large Minimum Quantities
 Not in current production

Socket Type



Thread Size (A)	Base Diameter (D) mm (in.)	Min.Thread Depth mm (in.)	Load Rating Kg	Part Number
Thread Size (A) 1/2-13 UNC (12.7 mm)				
1/2-13 UNC (12.7 mm)	47.60	11.20	315.0	MSF-127C-CGCAP Mounts - Levelling - Socket - Gold Chromate - Swivel - Acetal Base
1/2-13 UNC (12.7 mm)	47.60	11.20	1700.0	MSF-127C-S3RP Mounts - Levelling - Socket - 303 Stainless - Swivel - Rubber Padded
1/2-13 UNC (12.7 mm)	47.60	11.20	1700.0	MSF-127C-CBC Mounts - Levelling - Socket - Black Chromate - Swivel
1/2-20 UNF (12.7 mm)	47.60	11.20	1700.0	MSF-127F-CGC Mounts - Levelling - Socket - Gold Chromate - Swivel
1/2-13 UNC (12.7 mm)	47.60	11.20	1700.0	MSF-127C-CGCRP Mounts - Levelling - Socket - Gold Chromate - Swivel - Rubber Padded
1/2-13 UNC (12.7 mm)	47.60	11.20	2270.0	MSF-127C-S3 Mounts - Levelling - Socket - 303 Stainless - Swivel
1/2-13 UNC (12.7 mm)	47.60	11.20	2270.0	MLF-127C-S6 Mounts - Levelling - Socket - 316 Stainless
1/2-13 UNC (12.7 mm)	47.60	11.20	2270.0	MSF-127C-CCC Mounts - Levelling - Socket - Clear Chromate - Swivel
1/2-13 UNC (12.7 mm)	47.60	11.20	2270.0	MSF-127C-CGC-048 Mounts - Levelling - Socket - Gold Chromate - Swivel
1/2-10 (12.7 mm)	47.60	14.30	3400.0	MLF-127A-CGC Mounts - Levelling - Socket - Acme Thread - Gold Chromate
1/2-13 UNC (12.7 mm)	47.60	11.20	1700.0	MSF-127C-CBCRP Mounts - Levelling - Socket - Black Chromate - Swivel - Rubber Padded
1/2-13 UNC (12.7 mm)	47.60	11.20	1700.0	MSF-127C-CCCRP Mounts - Levelling - Socket - Clear Chromate - Swivel - Rubber Padded
1/2-13 UNC (12.7 mm)	101.60	-	1170.0	MLF-127C-S3NY-0LH Mounts - Levelling - Socket - Nylon - No Lag Holes
1/2-13 UNC (12.7 mm)	101.60	-	1180.0	MLF-127C-S3NY-2LH Mounts - Levelling - Socket - Nylon - With Lag Holes
Thread Size (A) 5/8-11 UNC (15.88 mm)				
5/8-11 UNC (15.88 mm)	63.50	-	2720.0	MSF-2720-159C-B Mounts - Levelling - Socket - Black Chromate - Swivel
5/8-11 UNC (15.88 mm)	63.50	-	2720.0	MSF-159C-C-2LH Mounts - Levelling - Socket - Swivel - With Lag Holes
5/8-11 UNC (15.88 mm)	63.50	11.20	540.0	MSF-159C-CGCAP Mounts - Levelling - Socket - Gold Chromate - Swivel - Acetal Base
5/8-11 UNC (15.88 mm)	63.50	11.20	2040.0	MSF-159C-S3RP Mounts - Levelling - Socket - 303 Stainless - Swivel - Rubber Padded
5/8-18 UNF (15.88 mm)	63.50	11.20	2040.0	MSF-159F-CGC Mounts - Levelling - Socket - Gold Chromate - Swivel
5/8-11 UNC (15.88 mm)	63.50	11.20	2040.0	MSF-159C-CGCRP Mounts - Levelling - Socket - Gold Chromate - Swivel - Rubber Padded
5/8-11 UNC (15.88 mm)	63.50	11.20	2720.0	MSF-159C-S3 Mounts - Levelling - Socket - 303 Stainless - Swivel
5/8-11 UNC (15.88 mm)	63.50	11.20	2720.0	MLF-159C-S6 Mounts - Levelling - Socket - 316 Stainless
5/8-11 UNC (15.88 mm)	63.50	11.20	2720.0	MSF-159C-CCC Mounts - Levelling - Socket - Clear Chromate - Swivel
5/8-11 UNC (15.88 mm)	63.50	11.20	2720.0	MSF-159C-CGC Mounts - Levelling - Socket - Gold Chromate - Swivel
5/8-11 UNC (15.88 mm)	63.50	11.20	2040.0	MSF-159C-CCCRP Mounts - Levelling - Socket - Clear Chromate - Swivel - Rubber Padded
5/8-11 UNC (15.88 mm)	101.60	-	1170.0	MLF-159C-S3NY-0LH Mounts - Levelling - Socket - Nylon - No Lag Holes
Thread Size (A) M16x2 (16 mm)				
M16x2 (16 mm)	64.00	11.00	2700.0	MSF-160M-S3 Mounts - Levelling - Socket - 303 Stainless - Swivel
M16x2 (16 mm)	64.00	11.20	2720.0	MSF-160M-CBC Mounts - Levelling - Socket - Black Chromate - Swivel



Usually stocked or Short Delivery
 ** Available while stocks last **

Long Delivery or Large Minimum Quantities
 Not in current production

Socket Type



Thread Size (A)	Base Diameter (D) mm (in.)	Min.Thread Depth mm (in.)	Load Rating Kg	Part Number
Thread Size (A) M16x2 (16 mm)				
M16x2 (16 mm)	64.00	11.20	2720.0	MSF-160M-CCC Mounts - Levelling - Socket - Clear Chromate - Swivel
M16x2 (16 mm)	64.00	11.20	2720.0	MSF-160M-CGC-064 Mounts - Levelling - Socket - Gold Chromate - Swivel
M16x2 (16 mm)	64.00	11.00	2040.0	MSF-160M-S3RP Mounts - Levelling - Socket - 303 Stainless - Swivel - Rubber Padded
M16x2 (16 mm)	64.00	11.20	2040.0	MSF-160M-CGCRP Mounts - Levelling - Socket - Gold Chromate - Swivel - Rubber Padded
Thread Size (A) 3/4-16 UNF (19.1 mm)				
3/4-16 UNF (19.1 mm)	76.20	-	3270.0	MSF-191F-C-2LH Mounts - Levelling - Socket - Swivel - With Lag Holes
3/4-10 UNC (19.1 mm)	76.20	15.80	820.0	MSF-191C-CGCP Mounts - Levelling - Socket - Gold Chromate - Swivel - Acetal Base
3/4-10 UNC (19.1 mm)	76.20	15.80	2450.0	MSF-191C-S3RP Mounts - Levelling - Socket - 303 Stainless - Swivel - Rubber Padded
3/4-16 UNF (19.1 mm)	76.20	15.80	2450.0	MSF-191F-CGC Mounts - Levelling - Socket - Gold Chromate - Swivel
3/4-10 UNC (19.1 mm)	76.20	15.80	2450.0	MSF-191C-CGCRP Mounts - Levelling - Socket - Gold Chromate - Swivel - Rubber Padded
3/4-10 UNC (19.1 mm)	76.20	15.80	3270.0	MSF-191C-CBC Mounts - Levelling - Socket - Black Chromate - Swivel
3/4-10 UNC (19.1 mm)	76.20	15.80	3270.0	MSF-191C-CCC Mounts - Levelling - Socket - Clear Chromate - Swivel
3/4-10 UNC (19.1 mm)	76.20	15.80	3270.0	MSF-191C-CGC Mounts - Levelling - Socket - Gold Chromate - Swivel
3/4-10 UNC (19.1 mm)	76.20	15.80	3270.0	MSF-191C-CNP Mounts - Levelling - Socket - Nickel Plated - Swivel
3/4-10 UNC (19.1 mm)	76.20	15.80	3350.0	MSF-191C-S3 Mounts - Levelling - Socket - 303 Stainless - Swivel
3/4-10 UNC (19.1 mm)	76.20	15.80	3350.0	MLF-191C-S6 Mounts - Levelling - Socket - 316 Stainless
3/4-6 (19.1 mm)	76.20	19.10	5030.0	MLF-191A-CGC Mounts - Levelling - Socket - Acme Thread - Gold Chromate
3/4-10 UNC (19.1 mm)	76.20	15.80	2450.0	MSF-191C-CBCRP Mounts - Levelling - Socket - Black Chromate - Swivel - Rubber Padded
3/4-10 UNC (19.1 mm)	101.60	-	1170.0	MLF-191C-S3NY-0LH-102 Mounts - Levelling - Socket - Nylon - No Lag Holes
3/4-10 UNC (19.1 mm)	101.60	-	1180.0	MLF-191C-S3NY-2LH Mounts - Levelling - Socket - Nylon - With Lag Holes
3/4-10 UNC (19.1 mm)	113.80	-	900.0	MLF-191C-S3NY-0LH-114 Mounts - Levelling - Socket - Nylon - No Lag Holes
Thread Size (A) M20x2.5 (20 mm)				
M20x2.5 (20 mm)	76.00	15.70	3270.0	MSF-200M-S3 Mounts - Levelling - Socket - 303 Stainless - Swivel
M20x2.5 (20 mm)	76.00	15.70	3270.0	MSF-200M-CBC Mounts - Levelling - Socket - Black Chromate - Swivel
M20x2.5 (20 mm)	76.00	15.70	3270.0	MSF-200M-CCC Mounts - Levelling - Socket - Clear Chromate - Swivel
M20x2.5 (20 mm)	76.00	15.70	3270.0	MSF-200M-CGC-076 Mounts - Levelling - Socket - Gold Chromate - Swivel
M20x2.5 (20 mm)	76.00	15.70	2450.0	MSF-200M-CGCRP Mounts - Levelling - Socket - Gold Chromate - Swivel - Rubber Padded
Thread Size (A) M24x3 (24 mm)				
M24x3 (24 mm)	102.00	20.00	9000.0	MSF-240M-CNP Mounts - Levelling - Socket - Nickel Plated - Swivel
M24x3 (24 mm)	102.00	20.60	7660.0	MSF-240M-S3 Mounts - Levelling - Socket - 303 Stainless - Swivel



 Usually stocked or Short Delivery
 ** Available while stocks last **

 Long Delivery or Large Minimum Quantities
 Not in current production

Socket Type



Thread Size (A)	Base Diameter (D) mm (in.)	Min.Thread Depth mm (in.)	Load Rating Kg	Part Number
Thread Size (A) M24x3 (24 mm)				
M24x3 (24 mm)	102.00	20.60	9980.0	MSF-240M-CGC Mounts - Levelling - Socket - Gold Chromate - Swivel
Thread Size (A) 1-8 UNC (25.4 mm)				
1-8 UNC (25.4 mm)	101.60	-	9980.0	MSF-254C-C-2LH Mounts - Levelling - Socket - Swivel - With Lag Holes
1-8 UNC (25.4 mm)	101.60	20.60	1090.0	MSF-254C-S3AP Mounts - Levelling - Socket - 303 Stainless - Swivel - Acetal Base
1-8 UNC (25.4 mm)	101.60	20.60	1090.0	MSF-254C-CGCAP Mounts - Levelling - Socket - Gold Chromate - Swivel - Acetal Base
1-8 UNC (25.4 mm)	101.60	20.60	6800.0	MSF-254C-S6RP Mounts - Levelling - Socket - 316 Stainless - Swivel - Rubber Padded
1-8 UNC (25.4 mm)	101.60	20.60	7440.0	MSF-254C-CGCRP Mounts - Levelling - Socket - Gold Chromate - Swivel - Rubber Padded
1-8 UNC (25.4 mm)	101.60	20.60	9530.0	MSF-254C-S3RP Mounts - Levelling - Socket - 303 Stainless - Swivel - Rubber Padded
1-8 UNC (25.4 mm)	101.60	20.60	9920.0	MSF-254C-CBC Mounts - Levelling - Socket - Black Chromate - Swivel
1-8 UNC (25.4 mm)	101.60	20.60	9920.0	MSF-254C-CCC Mounts - Levelling - Socket - Clear Chromate - Swivel
1-12 UNF (25.4 mm)	101.60	20.60	9980.0	MSF-254F-CGC Mounts - Levelling - Socket - Gold Chromate - Swivel
1-8 UNC (25.4 mm)	101.60	20.60	9980.0	MSF-254C-CGC Mounts - Levelling - Socket - Gold Chromate - Swivel
1-8 UNC (25.4 mm)	101.60	20.60	9980.0	MSF-254C-CNP Mounts - Levelling - Socket - Nickel Plated - Swivel
1-8 UNC (25.4 mm)	101.60	20.60	7440.0	MSF-254C-CBCRP Mounts - Levelling - Socket - Black Chromate - Swivel - Rubber Padded



 Usually stocked or Short Delivery
 ** Available while stocks last **

 Long Delivery or Large Minimum Quantities
 Not in current production

Studded Type



Thread Size (A)	Base Diameter (D) mm (in.)	Thread Length (F) mm (in.)	Load Rating Kg	Part Number
Thread Size (A) 10-32 UNF (4.76 mm)				
10-32 UNF (4.76 mm)	19.10	25.40	240.0	MSM-048F-025-S3AB Mounts - Levelling - Studded - 303 Stainless - Swivel - Acetal Base
10-32 UNF (4.76 mm)	19.10	25.40	315.0	MSM-048F-025-CBC Mounts - Levelling - Studded - Black Chromate - Swivel
10-32 UNF (4.76 mm)	19.10	25.40	315.0	MSM-048F-025-CCC Mounts - Levelling - Studded - Clear Chromate - Swivel
10-32 UNF (4.76 mm)	19.10	25.40	315.0	MLM-048F-025-CGC Mounts - Levelling - Studded - Gold Chromate
10-32 UNF (4.76 mm)	19.10	25.40	315.0	MSM-048F-025-CGC Mounts - Levelling - Studded - Gold Chromate - Swivel
10-32 UNF (4.76 mm)	19.10	25.40	315.0	MLM-048F-025-CNP Mounts - Levelling - Studded - Plated
10-32 UNF (4.76 mm)	19.10	25.40	410.0	MLM-048F-025-S3 Mounts - Levelling - Studded - 303 Stainless
10-32 UNF (4.76 mm)	19.10	25.40	410.0	MSM-048F-025-S3 Mounts - Levelling - Studded - 303 Stainless - Swivel
10-32 UNF (4.76 mm)	19.10	50.80	70.0	MSM-048F-051-S3AB Mounts - Levelling - Studded - 303 Stainless - Swivel - Acetal Base
10-32 UNF (4.76 mm)	19.10	50.80	315.0	MLM-048F-051-S3 Mounts - Levelling - Studded - 303 Stainless
10-32 UNF (4.76 mm)	19.10	50.80	315.0	MSM-048F-051-S3 Mounts - Levelling - Studded - 303 Stainless - Swivel
10-32 UNF (4.76 mm)	19.10	50.80	315.0	MSM-048F-051-CCC Mounts - Levelling - Studded - Clear Chromate - Swivel
10-32 UNF (4.76 mm)	19.10	50.80	315.0	MLM-048F-051-CGC Mounts - Levelling - Studded - Gold Chromate
10-32 UNF (4.76 mm)	19.10	50.80	315.0	MSM-048F-051-CGC Mounts - Levelling - Studded - Gold Chromate - Swivel
10-32 UNF (4.76 mm)	19.10	50.80	315.0	MLM-048F-051-CNP Mounts - Levelling - Studded - Plated
10-32 UNF (4.76 mm)	19.10	25.40	70.0	MSM-048F-025-CGCAB Mounts - Levelling - Studded - Gold Chromate - Swivel - Acetal Base
10-32 UNF (4.76 mm)	19.10	25.40	240.0	MSM-048F-025-CGCRP Mounts - Levelling - Studded - Gold Chromate - Swivel - Rubber Padded
10-32 UNF (4.76 mm)	19.10	25.40	290.0	MSM-048F-025-S3RP Mounts - Levelling - Studded - 303 Stainless - Swivel - Rubber Padded
10-32 UNF (4.76 mm)	19.10	50.80	240.0	MSM-048F-051-CGCRP Mounts - Levelling - Studded - Gold Chromate - Swivel - Rubber Padded
10-24 UNC (4.76 mm)	30.50	31.80	110.0	MLM-048C-032-S3NP-I Mounts - Levelling - Studded - 303 Stainless - Industrial - Nylon Padded
10-24 UNC (4.76 mm)	30.50	38.10	110.0	MLM-048C-038-CNP-I Mounts - Levelling - Studded - Industrial - Nylon Padded
Thread Size (A) M6x1 (6 mm)				
M6x1 (6 mm)	19.00	25.00	315.0	MSM-060M-025-S3 Mounts - Levelling - Studded - 303 Stainless - Swivel
M6x1 (6 mm)	19.00	25.00	230.0	MSM-060M-025-CNPRP Mounts - Levelling - Studded - Plated - Swivel - Rubber Padded
M6x1 (6 mm)	19.10	25.40	315.0	MLM-060M-025-S3 Mounts - Levelling - Studded - 303 Stainless
M6x1 (6 mm)	19.10	25.40	315.0	MLM-060M-025-CGC Mounts - Levelling - Studded - Gold Chromate
M6x1 (6 mm)	19.10	25.40	315.0	MLM-060M-025-CNP Mounts - Levelling - Studded - Plated
Thread Size (A) 1/4-16 (6.35 mm)				
1/4-16 (6.35 mm)	25.40	31.80	670.0	MLM-064A-032-CGC Mounts - Levelling - Studded - Acme Thread - Gold Chromate
1/4-20 UNC (6.35 mm)	25.40	31.80	360.0	MSM-064C-032-S3AB Mounts - Levelling - Studded - 303 Stainless - Swivel - Acetal Base



 Usually stocked or Short Delivery
 ** Available while stocks last **

 Long Delivery or Large Minimum Quantities
 Not in current production

Studded Type



Thread Size (A)	Base Diameter (D) mm (in.)	Thread Length (F) mm (in.)	Load Rating Kg	Part Number
Thread Size (A) 1/4-16 (6.35 mm)				
1/4-20 UNC (6.35 mm)	25.40	31.80	500.0	MSM-064C-032-CBC Mounts - Levelling - Studded - Black Chromate - Swivel
1/4-20 UNC (6.35 mm)	25.40	31.80	500.0	MSM-064C-032-CCC Mounts - Levelling - Studded - Clear Chromate - Swivel
1/4-20 UNC (6.35 mm)	25.40	31.80	500.0	MLM-064C-032-CGC Mounts - Levelling - Studded - Gold Chromate
1/4-20 UNC (6.35 mm)	25.40	31.80	500.0	MSM-064C-032-CGC Mounts - Levelling - Studded - Gold Chromate - Swivel
1/4-20 UNC (6.35 mm)	25.40	31.80	500.0	MLM-064C-032-CNP Mounts - Levelling - Studded - Plated
1/4-20 UNC (6.35 mm)	25.40	31.80	670.0	MLM-064C-032-S3 Mounts - Levelling - Studded - 303 Stainless
1/4-20 UNC (6.35 mm)	25.40	31.80	670.0	MSM-064C-032-S3 Mounts - Levelling - Studded - 303 Stainless - Swivel
1/4-20 UNC (6.35 mm)	25.40	38.10	500.0	MLM-064C-038-S3 Mounts - Levelling - Studded - 303 Stainless
1/4-20 UNC (6.35 mm)	25.40	38.10	500.0	MLM-064C-038-CGC Mounts - Levelling - Studded - Gold Chromate
1/4-20 UNC (6.35 mm)	25.40	38.10	500.0	MLM-064C-038-CNP Mounts - Levelling - Studded - Plated
1/4-20 UNC (6.35 mm)	25.40	63.50	500.0	MSM-064C-064-S3 Mounts - Levelling - Studded - 303 Stainless - Swivel
1/4-20 UNC (6.35 mm)	25.40	63.50	500.0	MSM-064C-064-CBC Mounts - Levelling - Studded - Black Chromate - Swivel
1/4-20 UNC (6.35 mm)	25.40	63.50	500.0	MSM-064C-064-CCC Mounts - Levelling - Studded - Clear Chromate - Swivel
1/4-20 UNC (6.35 mm)	25.40	63.50	500.0	MSM-064C-064-CGC Mounts - Levelling - Studded - Gold Chromate - Swivel
1/4-20 UNC (6.35 mm)	25.40	31.80	90.0	MSM-064C-032-CGCAB Mounts - Levelling - Studded - Gold Chromate - Swivel - Acetal Base
1/4-20 UNC (6.35 mm)	25.40	31.80	360.0	MSM-064C-032-CBCRP Mounts - Levelling - Studded - Black Chromate - Swivel - Rubber Padded
1/4-20 UNC (6.35 mm)	25.40	31.80	360.0	MSM-064C-032-CGCRP Mounts - Levelling - Studded - Gold Chromate - Swivel - Rubber Padded
1/4-20 UNC (6.35 mm)	25.40	31.80	450.0	MSM-064C-032-S3RP Mounts - Levelling - Studded - 303 Stainless - Swivel - Rubber Padded
1/4-20 UNC (6.35 mm)	25.40	63.50	90.0	MSM-064C-064-CGCAB Mounts - Levelling - Studded - Gold Chromate - Swivel - Acetal Base
1/4-20 UNC (6.35 mm)	25.40	63.50	360.0	MSM-064C-064-S3RP Mounts - Levelling - Studded - 303 Stainless - Swivel - Rubber Padded
1/4-20 UNC (6.35 mm)	25.40	63.50	360.0	MSM-064C-064-CGCRP Mounts - Levelling - Studded - Gold Chromate - Swivel - Rubber Padded
1/4-20 UNC (6.35 mm)	25.40	31.80	360.0	MSM-064C-032-CCCRP Mounts - Levelling - Studded - Clear Chromate - Swivel - Rubber Padded
1/4-20 UNC (6.35 mm)	25.40	63.50	340.0	MSM-064C-064-CNPRP Mounts - Levelling - Studded - Plated - Swivel - Rubber Padded
1/4-20 UNC (6.35 mm)	25.40	63.50	360.0	MSM-064C-064-CCCRP Mounts - Levelling - Studded - Clear Chromate - Swivel - Rubber Padded
1/4-20 UNC (6.35 mm)	30.50	31.80	110.0	MLM-064C-032-S3NP-I Mounts - Levelling - Studded - 303 Stainless - Industrial - Nylon Padded
1/4-20 UNC (6.35 mm)	30.50	31.80	110.0	MLM-064C-032-CRP-I Mounts - Levelling - Studded - Industrial - Rubber Padded
1/4-20 UNC (6.35 mm)	30.50	38.10	110.0	MLM-064C-038-S3RP-I Mounts - Levelling - Studded - 303 Stainless - Industrial - Rubber Padded
1/4-20 UNC (6.35 mm)	30.50	38.10	110.0	MLM-064C-038-CNP-I Mounts - Levelling - Studded - Industrial - Nylon Padded
1/4-20 UNC (6.35 mm)	35.10	38.10	140.0	MLM-064C-038-CNP-LD Mounts - Levelling - Studded - Light Duty - Nylon Padded



 Usually stocked or Short Delivery
 ** Available while stocks last **

 Long Delivery or Large Minimum Quantities
 Not in current production

Studded Type



Thread Size (A)	Base Diameter (D) mm (in.)	Thread Length (F) mm (in.)	Load Rating Kg	Part Number
Thread Size (A) 1/4-16 (6.35 mm)				
1/4-20 UNC (6.35 mm)	38.10	38.10	140.0	MLM-064C-038-C-LDRP Mounts - Levelling - Studded - Light Duty - Rubber Padded
1/4-28 UNF (6.35 mm)	50.80	44.50	45.0	MLM-064F-CEB-OSHAY Mounts - Levelling - Studded - Elastomer Base - OSHA Yellow
Thread Size (A) 5/16-18 UNC (7.94 mm)				
5/16-18 UNC (7.94 mm)	30.50	31.80	110.0	MLM-079C-032-S3NP-I Mounts - Levelling - Studded - 303 Stainless - Industrial - Nylon Padded
5/16-18 UNC (7.94 mm)	30.50	31.80	110.0	MLM-079C-032-CRP-I Mounts - Levelling - Studded - Industrial - Rubber Padded
5/16-18 UNC (7.94 mm)	30.50	38.10	110.0	MLM-079C-038-S3RP-I Mounts - Levelling - Studded - 303 Stainless - Industrial - Rubber Padded
5/16-18 UNC (7.94 mm)	30.50	38.10	110.0	MLM-079C-038-CNP-I Mounts - Levelling - Studded - Industrial - Nylon Padded
5/16-18 UNC (7.94 mm)	32.00	38.10	78.0	MLM-079C-038-TP-032 Mounts - Levelling - Studded - Thermoplastic
5/16-18 UNC (7.94 mm)	35.10	38.10	140.0	MLM-079C-038-CNP-LD Mounts - Levelling - Studded - Light Duty - Nylon Padded
5/16-18 UNC (7.94 mm)	38.10	38.10	140.0	MLM-079C-038-C-LDRP Mounts - Levelling - Studded - Light Duty - Rubber Padded
5/16-18 UNC (7.94 mm)	39.10	47.80	315.0	MLM-079C-048-S3NY-OLH Mounts - Levelling - Studded - Nylon - No Lag Holes
5/16-18 UNC (7.94 mm)	39.10	47.80	315.0	MLM-079C-048-CNY-OLH Mounts - Levelling - Studded - Nylon - No Lag Holes
5/16-18 UNC (7.94 mm)	39.10	73.20	315.0	MLM-079C-073-S3NY-OLH Mounts - Levelling - Studded - Nylon - No Lag Holes
5/16-18 UNC (7.94 mm)	39.90	38.10	78.0	MLM-079C-038-TP-040 Mounts - Levelling - Studded - Thermoplastic
5/16-18 UNC (7.94 mm)	51.60	50.80	110.0	MLM-079C-051-S3NP-I Mounts - Levelling - Studded - 303 Stainless - Industrial - Nylon Padded
5/16-18 UNC (7.94 mm)	51.60	50.80	110.0	MLM-079C-051-S3RP-I Mounts - Levelling - Studded - 303 Stainless - Industrial - Rubber Padded
5/16-18 UNC (7.94 mm)	51.60	50.80	110.0	MLM-079C-051-CNP-I Mounts - Levelling - Studded - Industrial - Nylon Padded
5/16-18 UNC (7.94 mm)	51.60	50.80	110.0	MLM-079C-051-CRP-I Mounts - Levelling - Studded - Industrial - Rubber Padded
Thread Size (A) M8x1.25 (8 mm)				
M8x1.25 (8 mm)	25.00	32.00	450.0	MSM-080M-032-CNP Mounts - Levelling - Studded - Plated - Swivel
M8x1.25 (8 mm)	25.00	32.00	340.0	MSM-080M-032-S3RP Mounts - Levelling - Studded - 303 Stainless - Swivel - Rubber Padded
M8x1.25 (8 mm)	25.40	31.80	500.0	MLM-080M-032-S3 Mounts - Levelling - Studded - 303 Stainless
M8x1.25 (8 mm)	25.40	31.80	500.0	MLM-080M-032-CGC Mounts - Levelling - Studded - Gold Chromate
M8x1.25 (8 mm)	25.40	31.80	500.0	MLM-080M-032-CNP Mounts - Levelling - Studded - Plated
M8x1.25 (8 mm)	32.00	45.00	100.0	MLM-080M-045-TP-032 Mounts - Levelling - Studded - Thermoplastic
M8x1.25 (8 mm)	32.00	70.00	100.0	MLM-080M-070-TP-032 Mounts - Levelling - Studded - Thermoplastic
M8x1.25 (8 mm)	39.10	38.00	315.0	MLM-080M-038-S3NY-OLH-039 Mounts - Levelling - Studded - Nylon - No Lag Holes
M8x1.25 (8 mm)	39.10	38.00	315.0	MLM-080M-038-CNY-OLH-039 Mounts - Levelling - Studded - Nylon - No Lag Holes
M8x1.25 (8 mm)	39.10	64.00	315.0	MLM-080M-064-CNY-OLH Mounts - Levelling - Studded - Nylon - No Lag Holes
M8x1.25 (8 mm)	40.00	45.00	100.0	MLM-080M-045-TP-040 Mounts - Levelling - Studded - Thermoplastic



 Usually stocked or Short Delivery
 ** Available while stocks last **

 Long Delivery or Large Minimum Quantities
 Not in current production

Studded Type



Thread Size (A)	Base Diameter (D) mm (in.)	Thread Length (F) mm (in.)	Load Rating Kg	Part Number
Thread Size (A) M8x1.25 (8 mm)				
M8x1.25 (8 mm)	40.00	70.00	100.0	MLM-080M-070-TP Mounts - Levelling - Studded - Thermoplastic
M8x1.25 (8 mm)	40.00	60.00	350.0	MLM-080M-060-S4RP-I Mounts - Levelling - Studded - 303 Stainless - Industrial - Rubber Padded
M8x1.25 (8 mm)	40.00	60.00	350.0	MLM-080M-060-CZRP Mounts - Levelling - Studded - Black Chromate - Swivel - Rubber Padded
M8x1.25 (8 mm)	40.00	60.00	350.0	MLM-080M-060-S4RP Mounts - Levelling - Studded - Black Chromate - Swivel - Rubber Padded
M8x1.25	45.00	60.00	20.6	MLM-080M-060-ZRP-ECO Mounts - Levelling - Studded - Economy - Rubber Padded
M8x1.25 (8 mm)	48.80	38.00	315.0	MLM-080M-038-CNY-0LH-049 Mounts - Levelling - Studded - Nylon - No Lag Holes
M8x1.25 (8 mm)	50.00	50.00	400.0	MLM-080M-050-S4 Mounts - Levelling - Studded - 303 Stainless
M8x1.25 (8 mm)	50.00	50.00	400.0	MLM-080M-050-CZRP Mounts - Levelling - Studded - Plated
M8x1.25 (8 mm)	50.00	80.00	400.0	MLM-080M-080-S4 Mounts - Levelling - Studded - 303 Stainless
M8x1.25 (8 mm)	50.00	80.00	400.0	MLM-080M-080-CZRP Mounts - Levelling - Studded - Plated
M8x1.25 (8 mm)	50.00	45.00	100.0	MLM-080M-045-TP-050 Mounts - Levelling - Studded - Thermoplastic
M8x1.25 (8 mm)	50.00	70.00	100.0	MLM-080M-070-TP-050 Mounts - Levelling - Studded - Thermoplastic
M8x1.25 (8 mm)	50.00	50.00	180.0	MLM-080M-050-CNY-0LH Mounts - Levelling - Studded - Nylon - No Lag Holes
M8x1.25 (8 mm)	50.00	50.00	210.0	MLM-080M-050-S4NY-0LH Mounts - Levelling - Studded - Nylon - No Lag Holes
M8x1.25 (8 mm)	50.00	80.00	180.0	MLM-080M-080-CNY-0LH Mounts - Levelling - Studded - Nylon - No Lag Holes
M8x1.25 (8 mm)	50.00	80.00	210.0	MLM-080M-080-S4NY-0LH Mounts - Levelling - Studded - Nylon - No Lag Holes
M8x1.25	50.00	50.00	39.2	MLM-080M-050-ZPP-ECO Mounts - Levelling - Studded - Economy - PVC Padded
M8x1.25	50.00	80.00	39.2	MLM-080M-080-ZPP-ECO Mounts - Levelling - Studded - Economy - PVC Padded
M8x1.25 (8 mm)	50.00	50.00	400.0	MSM-080M-050-S4RP Mounts - Levelling - Studded - 303 Stainless - Swivel - Rubber Padded
M8x1.25 (8 mm)	50.00	80.00	400.0	MSM-080M-080-S4RP Mounts - Levelling - Studded - 303 Stainless - Swivel - Rubber Padded
M8x1.25 (8 mm)	80.00	45.00	100.0	MLM-080M-045-TP-2LH Mounts - Levelling - Studded - Thermoplastic
M8x1.25 (8 mm)	80.00	45.00	100.0	MLM-080M-045-TP-080 Mounts - Levelling - Studded - Thermoplastic
M8x1.25 (8 mm)	80.00	70.00	100.0	MLM-080M-070-TP-2LH Mounts - Levelling - Studded - Thermoplastic
Thread Size (A) 3/8-16 UNC (9.53 mm)				
3/8-16 UNC (9.53 mm)	31.80	50.80	1270.0	MSM-095C-051-S3AB Mounts - Levelling - Studded - 303 Stainless - Swivel - Acetal Base
3/8-16 UNC (9.53 mm)	31.80	50.80	1700.0	MLM-095C-051-S3 Mounts - Levelling - Studded - 303 Stainless
3/8-16 UNC (9.53 mm)	31.80	50.80	1700.0	MSM-095C-051-S3 Mounts - Levelling - Studded - 303 Stainless - Swivel
3/8-16 UNC (9.53 mm)	31.80	50.80	1700.0	MLM-095C-051-CBC Mounts - Levelling - Studded - Black Chromate
3/8-16 UNC (9.53 mm)	31.80	50.80	1700.0	MSM-095C-051-CBC Mounts - Levelling - Studded - Black Chromate - Swivel



 Usually stocked or Short Delivery
 ** Available while stocks last **

 Long Delivery or Large Minimum Quantities
 Not in current production

Studded Type



Thread Size (A)	Base Diameter (D) mm (in.)	Thread Length (F) mm (in.)	Load Rating Kg	Part Number
Thread Size (A) 3/8-16 UNC (9.53 mm)				
3/8-16 UNC (9.53 mm)	31.80	50.80	1700.0	MSM-095C-051-CCC Mounts - Levelling - Studded - Clear Chromate - Swivel
3/8-16 UNC (9.53 mm)	31.80	50.80	1700.0	MLM-095C-051-CGC Mounts - Levelling - Studded - Gold Chromate
3/8-16 UNC (9.53 mm)	31.80	50.80	1700.0	MSM-095C-051-CGC Mounts - Levelling - Studded - Gold Chromate - Swivel
3/8-24 UNF (9.53 mm)	31.80	50.80	1700.0	MSM-095F-051-CGC Mounts - Levelling - Studded - Gold Chromate - Swivel
3/8-16 UNC (9.53 mm)	31.80	50.80	1700.0	MLM-095C-051-CNP Mounts - Levelling - Studded - Plated
3/8-16 UNC (9.53 mm)	31.80	101.60	1700.0	MLM-095C-102-S3 Mounts - Levelling - Studded - 303 Stainless
3/8-16 UNC (9.53 mm)	31.80	101.60	1700.0	MSM-095C-102-S3 Mounts - Levelling - Studded - 303 Stainless - Swivel
3/8-16 UNC (9.53 mm)	31.80	101.60	1700.0	MSM-095C-102-CBC Mounts - Levelling - Studded - Black Chromate - Swivel
3/8-16 UNC (9.53 mm)	31.80	101.60	1700.0	MSM-095C-102-CCC Mounts - Levelling - Studded - Clear Chromate - Swivel
3/8-16 UNC (9.53 mm)	31.80	101.60	1700.0	MLM-095C-102-CGC Mounts - Levelling - Studded - Gold Chromate
3/8-16 UNC (9.53 mm)	31.80	101.60	1700.0	MSM-095C-102-CGC Mounts - Levelling - Studded - Gold Chromate - Swivel
3/8-16 UNC (9.53 mm)	31.80	101.60	1700.0	MLM-095C-102-CNP Mounts - Levelling - Studded - Plated
3/8-16 UNC (9.53 mm)	31.80	50.80	140.0	MSM-095C-051-CGCAB Mounts - Levelling - Studded - Gold Chromate - Swivel - Acetal Base
3/8-16 UNC (9.53 mm)	31.80	50.80	1270.0	MSM-095C-051-S3RP Mounts - Levelling - Studded - 303 Stainless - Swivel - Rubber Padded
3/8-16 UNC (9.53 mm)	31.80	50.80	1270.0	MSM-095C-051-S6RP Mounts - Levelling - Studded - 316 Stainless - Swivel - Rubber Padded
3/8-16 UNC (9.53 mm)	31.80	50.80	1270.0	MSM-095C-051-CBCRP Mounts - Levelling - Studded - Black Chromate - Swivel - Rubber Padded
3/8-16 UNC (9.53 mm)	31.80	50.80	1270.0	MSM-095C-051-CGCRP Mounts - Levelling - Studded - Gold Chromate - Swivel - Rubber Padded
3/8-16 UNC (9.53 mm)	31.80	101.60	140.0	MSM-095C-102-CGCAB Mounts - Levelling - Studded - Gold Chromate - Swivel - Acetal Base
3/8-16 UNC (9.53 mm)	31.80	101.60	1270.0	MSM-095C-102-S3RP Mounts - Levelling - Studded - 303 Stainless - Swivel - Rubber Padded
3/8-16 UNC (9.53 mm)	31.80	101.60	1270.0	MSM-095C-102-CBCRP Mounts - Levelling - Studded - Black Chromate - Swivel - Rubber Padded
3/8-16 UNC (9.53 mm)	31.80	101.60	1270.0	MSM-095C-102-CGCRP Mounts - Levelling - Studded - Gold Chromate - Swivel - Rubber Padded
3/8-16 UNC (9.53 mm)	31.80	101.60	1300.0	MSM-095C-102-CCCRP Mounts - Levelling - Studded - Clear Chromate - Swivel - Rubber Padded
3/8-16 UNC (9.53 mm)	32.00	44.50	78.0	MLM-095C-045-TP-032 Mounts - Levelling - Studded - Thermoplastic
3/8-16 UNC (9.53 mm)	39.10	47.80	315.0	MLM-095C-048-S3NY-0LH Mounts - Levelling - Studded - Nylon - No Lag Holes
3/8-16 UNC (9.53 mm)	39.10	47.80	315.0	MLM-095C-048-CNY-0LH Mounts - Levelling - Studded - Nylon - No Lag Holes
3/8-16 UNC (9.53 mm)	39.10	73.20	315.0	MLM-095C-073-S3NY-0LH Mounts - Levelling - Studded - Nylon - No Lag Holes
3/8-16 UNC (9.53 mm)	39.10	73.20	315.0	MLM-095C-073-CNY-0LH Mounts - Levelling - Studded - Nylon - No Lag Holes
3/8-16 UNC (9.53 mm)	39.90	44.50	78.0	MLM-095C-045-TP-040 Mounts - Levelling - Studded - Thermoplastic
3/8-16 UNC (9.53 mm)	50.80	50.80	140.0	MLM-095C-051-CNP-LD Mounts - Levelling - Studded - Light Duty - Nylon Padded



 Usually stocked or Short Delivery
 ** Available while stocks last **

 Long Delivery or Large Minimum Quantities
 Not in current production

Studded Type



Thread Size (A)	Base Diameter (D) mm (in.)	Thread Length (F) mm (in.)	Load Rating Kg	Part Number
Thread Size (A) 3/8-16 UNC (9.53 mm)				
3/8-16 UNC (9.53 mm)	50.80	50.80	140.0	MLM-095C-051-C-LDRP Mounts - Levelling - Studded - Light Duty - Rubber Padded
3/8-16 UNC (9.53 mm)	51.60	50.80	110.0	MLM-095C-051-S3NP-I-052 Mounts - Levelling - Studded - 303 Stainless - Industrial - Nylon Padded
3/8-16 UNC (9.53 mm)	51.60	50.80	110.0	MLM-095C-051-S3RP-I-052 Mounts - Levelling - Studded - 303 Stainless - Industrial - Rubber Padded
3/8-16 UNC (9.53 mm)	51.60	50.80	110.0	MLM-095C-051-CNP-I-052 Mounts - Levelling - Studded - Industrial - Nylon Padded
3/8-16 UNC (9.53 mm)	51.60	50.80	110.0	MLM-095C-051-CRP-I-052 Mounts - Levelling - Studded - Industrial - Rubber Padded
3/8-16 UNC (9.53 mm)	61.00	50.80	110.0	MLM-095C-051-S3NP-I-061 Mounts - Levelling - Studded - 303 Stainless - Industrial - Nylon Padded
3/8-16 UNC (9.53 mm)	61.00	50.80	110.0	MLM-095C-051-S3RP-I-061 Mounts - Levelling - Studded - 303 Stainless - Industrial - Rubber Padded
3/8-16 UNC (9.53 mm)	61.00	50.80	110.0	MLM-095C-051-CNP-I-061 Mounts - Levelling - Studded - Industrial - Nylon Padded
3/8-16 UNC (9.53 mm)	61.00	50.80	110.0	MLM-095C-051-CRP-I-061 Mounts - Levelling - Studded - Industrial - Rubber Padded
3/8-16 UNC (9.53 mm)	61.00	101.60	110.0	MLM-095C-102-S3NP-I Mounts - Levelling - Studded - 303 Stainless - Industrial - Nylon Padded
3/8-16 UNC (9.53 mm)	61.00	101.60	110.0	MLM-095C-102-S3RP-I Mounts - Levelling - Studded - 303 Stainless - Industrial - Rubber Padded
3/8-16 UNC (9.53 mm)	61.00	101.60	110.0	MLM-095C-102-CRP-I Mounts - Levelling - Studded - Industrial - Rubber Padded
3/8-16 UNC (9.53 mm)	78.70	61.50	900.0	MLM-095C-062-S3NY-0LH Mounts - Levelling - Studded - Nylon - No Lag Holes
3/8-16 UNC (9.53 mm)	78.70	61.50	900.0	MLM-095C-062-CNY-0LH Mounts - Levelling - Studded - Nylon - No Lag Holes
3/8-16 UNC (9.53 mm)	78.70	61.50	900.0	MLM-095C-062-CNY-2LH Mounts - Levelling - Studded - Nylon - With Lag Holes
3/8-16 UNC (9.53 mm)	78.70	61.50	900.0	MLM-095C-062-S3NY-2LH Mounts - Levelling - Studded - Nylon - With Lag Holes
3/8-24 UNF (9.53 mm)	79.40	76.20	135.0	MLM-095F-CEB-OSHAY Mounts - Levelling - Studded - Elastomer Base - OSHA Yellow
Thread Size (A) M10x1.5 (10 mm)				
M10x1.5 (10 mm)	32.00	45.00	100.0	MLM-100M-045-TP-032 Mounts - Levelling - Studded - Thermoplastic
M10x1.5 (10 mm)	32.00	51.00	1700.0	MLM-100M-051-S3 Mounts - Levelling - Studded - 303 Stainless
M10x1.5 (10 mm)	32.00	51.00	1700.0	MSM-100M-051-S3 Mounts - Levelling - Studded - 303 Stainless - Swivel
M10x1.5 (10 mm)	32.00	51.00	1700.0	MSM-100M-051-CBC Mounts - Levelling - Studded - Black Chromate - Swivel
M10x1.5 (10 mm)	32.00	51.00	1700.0	MSM-100M-051-CCC Mounts - Levelling - Studded - Clear Chromate - Swivel
M10x1.5 (10 mm)	32.00	51.00	1700.0	MLM-100M-051-CGC Mounts - Levelling - Studded - Gold Chromate
M10x1.5 (10 mm)	32.00	51.00	1700.0	MSM-100M-051-CGC Mounts - Levelling - Studded - Gold Chromate - Swivel
M10x1.5 (10 mm)	32.00	51.00	1700.0	MLM-100M-051-CNP Mounts - Levelling - Studded - Plated
M10x1.5 (10 mm)	32.00	51.00	136.0	MSM-100M-051-CGCAB Mounts - Levelling - Studded - Gold Chromate - Swivel - Acetal Base
M10x1.5 (10 mm)	32.00	51.00	1270.0	MSM-100M-051-CBCRP Mounts - Levelling - Studded - Black Chromate - Swivel - Rubber Padded
M10x1.5 (10 mm)	32.00	51.00	1270.0	MSM-100M-051-CGCRP Mounts - Levelling - Studded - Gold Chromate - Swivel - Rubber Padded



 Usually stocked or Short Delivery
 ** Available while stocks last **

 Long Delivery or Large Minimum Quantities
 Not in current production

Studded Type

Thread Size (A)	Base Diameter (D) mm (in.)	Thread Length (F) mm (in.)	Load Rating Kg	Part Number
Thread Size (A) M10x1.5 (10 mm)				
M10x1.5 (10 mm)	32.00	51.00	1270.0	MSM-100M-051-CNPRP Mounts - Levelling - Studded - Plated - Swivel - Rubber Padded
M10x1.50	38.00	80.00	39.2	MLM-100M-080-S4-ECO Mounts - Levelling - Studded - Economy - Plain Base
M10x1.50	38.00	80.00	39.2	MLM-100M-080-Z-ECO Mounts - Levelling - Studded - Economy - Plain Base
M10x1.50	38.00	100.00	39.2	MLM-100M-100-S4-ECO Mounts - Levelling - Studded - Economy - Plain Base
M10x1.50	38.00	100.00	39.2	MLM-100M-100-Z-ECO Mounts - Levelling - Studded - Economy - Plain Base
M10x1.5 (10 mm)	39.10	64.00	315.0	MLM-100M-064-CNY-0LH-039 Mounts - Levelling - Studded - Nylon - No Lag Holes
M10x1.5 (10 mm)	40.00	70.00	100.0	MLM-100M-070-TP Mounts - Levelling - Studded - Thermoplastic
M10x1.5 (10 mm)	40.00	80.00	350.0	MLM-100M-080-S4RP-I Mounts - Levelling - Studded - 303 Stainless - Industrial - Rubber Padded
M10x1.5 (10 mm)	40.00	80.00	350.0	MLM-100M-080-CZRP Mounts - Levelling - Studded - Black Chromate - Swivel - Rubber Padded
M10x1.5 (10 mm)	40.00	80.00	350.0	MLM-100M-080-S4RP Mounts - Levelling - Studded - Black Chromate - Swivel - Rubber Padded
M10x1.50	45.00	80.00	22.5	MLM-100M-080-ZRP-ECO Mounts - Levelling - Studded - Economy - Rubber Padded
M10x1.50	45.00	100.00	22.5	MLM-100M-100-ZRP-ECO Mounts - Levelling - Studded - Economy - Rubber Padded
M10x1.5 (10 mm)	48.80	38.00	315.0	MLM-100M-038-S3NY-0LH Mounts - Levelling - Studded - Nylon - No Lag Holes
M10x1.5 (10 mm)	48.80	38.00	315.0	MLM-100M-038-CNY-0LH Mounts - Levelling - Studded - Nylon - No Lag Holes
M10x1.5 (10 mm)	48.80	64.00	315.0	MLM-100M-064-CNY-0LH-049 Mounts - Levelling - Studded - Nylon - No Lag Holes
M10x1.5 (10 mm)	48.80	64.00	315.0	MLM-100M-064-S3NY-0LH Mounts - Levelling - Studded - Nylon - No Lag Holes
M10x1.5 (10 mm)	50.00	45.00	100.0	MLM-100M-045-TP-050 Mounts - Levelling - Studded - Thermoplastic
M10x1.5 (10 mm)	50.00	70.00	100.0	MLM-100M-070-TP-050 Mounts - Levelling - Studded - Thermoplastic
M10x1.5 (10 mm)	60.00	80.00	500.0	MLM-100M-080-S4 Mounts - Levelling - Studded - 303 Stainless
M10x1.5 (10 mm)	60.00	100.00	500.0	MLM-100M-100-S4 Mounts - Levelling - Studded - 303 Stainless
M10x1.5 (10 mm)	60.00	100.00	500.0	MLM-100M-100-CZRP Mounts - Levelling - Studded - Plated
M10x1.5 (10 mm)	60.00	80.00	1.5	MLM-100M-080-NYCZ Mounts - Levelling - Studded - Nylon - No Lag Holes
M10x1.5 (10 mm)	60.00	80.00	150.0	MLM-100M-080-NY-S4 Mounts - Levelling - Studded - Nylon - No Lag Holes
M10x1.5 (10 mm)	60.00	100.00	150.0	MLM-100M-100-NYCZ Mounts - Levelling - Studded - Nylon - No Lag Holes
M10x1.5 (10 mm)	60.00	100.00	150.0	MLM-100M-100-NY-S4 Mounts - Levelling - Studded - Nylon - No Lag Holes
M10x1.5 (10 mm)	60.00	80.00	50.0	MSM-100M-080-S4RP Mounts - Levelling - Studded - 303 Stainless - Swivel - Rubber Padded
M10x1.5 (10 mm)	60.00	80.00	50.0	MSM-100M-080-CZRP Mounts - Levelling - Studded - 303 Stainless - Swivel - Rubber Padded
M10x1.5 (10 mm)	60.00	80.00	210.0	MLM-100M-080-S4NPRP Mounts - Levelling - Studded - Nylon - No Lag Holes
M10x1.5 (10 mm)	60.00	80.00	210.0	MLM-100M-080-CNY-0LH Mounts - Levelling - Studded - Nylon - No Lag Holes

 Usually stocked or Short Delivery
 ** Available while stocks last **

 Long Delivery or Large Minimum Quantities
 Not in current production

Studded Type

Thread Size (A)	Base Diameter (D) mm (in.)	Thread Length (F) mm (in.)	Load Rating Kg	Part Number
Thread Size (A) M10x1.5 (10 mm)				
M10x1.5 (10 mm)	60.00	80.00	210.0	MLM-100M-080-S4NY-0LH Mounts - Levelling - Studded - Nylon - No Lag Holes
M10x1.5 (10 mm)	60.00	100.00	210.0	MLM-100M-100-S4NY-0LH Mounts - Levelling - Studded - Nylon - No Lag Holes
M10x1.5 (10 mm)	60.00	100.00	210.0	MLM-100M-100-S4NPRP Mounts - Levelling - Studded - Nylon - No Lag Holes
M10x1.5 (10 mm)	60.00	100.00	210.0	MLM-100M-100-CNY-0LH Mounts - Levelling - Studded - Nylon - No Lag Holes
M10x1.5 (10 mm)	60.00	100.00	500.0	MSM-100M-100-CZRP Mounts - Levelling - Studded - 303 Stainless - Swivel - Rubber Padded
M10x1.5 (10 mm)	60.00	100.00	500.0	MSM-100M-100-S4RP Mounts - Levelling - Studded - 303 Stainless - Swivel - Rubber Padded
M10x1.50	60.00	80.00	49.0	MLM-100M-080-S4PP-ECO Mounts - Levelling - Studded - Economy - PVC Padded
M10x1.50	60.00	80.00	49.0	MLM-100M-080-ZPP-ECO Mounts - Levelling - Studded - Economy - PVC Padded
M10x1.50	60.00	100.00	49.0	MLM-100M-100-ZPP-ECO Mounts - Levelling - Studded - Economy - PVC Padded
M10x1.50	60.00	100.00	49.0	MLM-100M-100-S4PP-ECO Mounts - Levelling - Studded - Economy - PVC Padded
M10x1.5 (10 mm)	80.00	45.00	100.0	MLM-100M-045-TP-2LH Mounts - Levelling - Studded - Thermoplastic
M10x1.5 (10 mm)	80.00	45.00	100.0	MLM-100M-045-TP-080 Mounts - Levelling - Studded - Thermoplastic
M10x1.5 (10 mm)	80.00	70.00	100.0	MLM-100M-070-TP-2LH Mounts - Levelling - Studded - Thermoplastic
Thread Size (A) M12x1.75 (12 mm)				
M12x1.75 (12 mm)	39.10	64.00	315.0	MLM-120M-064-S3NY-0LH-039 Mounts - Levelling - Studded - Nylon - No Lag Holes
M12x1.75 (12 mm)	48.00	51.00	2200.0	MSM-120M-051-CBC Mounts - Levelling - Studded - Black Chromate - Swivel
M12x1.75 (12 mm)	48.00	51.00	2250.0	MSM-120M-051-CNP Mounts - Levelling - Studded - Plated - Swivel
M12x1.75 (12 mm)	48.00	51.00	2270.0	MLM-120M-051-S3 Mounts - Levelling - Studded - 303 Stainless
M12x1.75 (12 mm)	48.00	51.00	2270.0	MSM-120M-051-CCC Mounts - Levelling - Studded - Clear Chromate - Swivel
M12x1.75 (12 mm)	48.00	51.00	2270.0	MLM-120M-051-CGC Mounts - Levelling - Studded - Gold Chromate
M12x1.75 (12 mm)	48.00	51.00	2270.0	MSM-120M-051-CGC Mounts - Levelling - Studded - Gold Chromate - Swivel
M12x1.75 (12 mm)	48.00	51.00	2270.0	MLM-120M-051-CNP Mounts - Levelling - Studded - Plated
M12x1.75 (12 mm)	48.00	51.00	315.0	MSM-120M-051-CGCAB Mounts - Levelling - Studded - Gold Chromate - Swivel - Acetal Base
M12x1.75 (12 mm)	48.00	51.00	1700.0	MSM-120M-051-CGCRP Mounts - Levelling - Studded - Gold Chromate - Swivel - Rubber Padded
M12x1.75 (12 mm)	48.80	64.00	315.0	MLM-120M-064-S3NY-0LH-049 Mounts - Levelling - Studded - Nylon - No Lag Holes
M12x1.75 (12 mm)	48.80	123.00	315.0	MLM-120M-123-S3NY-0LH Mounts - Levelling - Studded - Nylon - No Lag Holes
M12x1.75 (12 mm)	48.80	123.00	315.0	MLM-120M-123-CNY-0LH Mounts - Levelling - Studded - Nylon - No Lag Holes
M12x1.75 (12 mm)	50.00	80.00	400.0	MLM-120M-080-S4RP-I Mounts - Levelling - Studded - 303 Stainless - Industrial - Rubber Padded
M12x1.75 (12 mm)	50.00	80.00	400.0	MLM-120M-080-CZRP Mounts - Levelling - Studded - Black Chromate - Swivel - Rubber Padded

Usually stocked or Short Delivery
 ** Available while stocks last **

Long Delivery or Large Minimum Quantities
 Not in current production

Studded Type



Thread Size (A)	Base Diameter (D) mm (in.)	Thread Length (F) mm (in.)	Load Rating Kg	Part Number
Thread Size (A) M12x1.75 (12 mm)				
M12x1.75 (12 mm)	50.00	80.00	400.0	MLM-120M-080-S4RP Mounts - Levelling - Studded - Black Chromate - Swivel - Rubber Padded
M12x1.75 (12 mm)	50.00	100.00	400.0	MLM-120M-100-S4RP-I Mounts - Levelling - Studded - 303 Stainless - Industrial - Rubber Padded
M12x1.75 (12 mm)	50.00	100.00	400.0	MLM-120M-100-CZRP Mounts - Levelling - Studded - Black Chromate - Swivel - Rubber Padded
M12x1.75 (12 mm)	50.00	100.00	400.0	MLM-120M-100-S4RP Mounts - Levelling - Studded - Black Chromate - Swivel - Rubber Padded
M12x1.75 (12 mm)	50.00	45.00	100.0	MLM-120M-045-TP Mounts - Levelling - Studded - Thermoplastic
M12x1.75	60.00	100.00	44.1	MLM-120M-100-Z-ECO Mounts - Levelling - Studded - Economy - Plain Base
M12x1.75	60.00	100.00	44.1	MLM-120M-100-S4-ECO Mounts - Levelling - Studded - Economy - Plain Base
M12x1.75	60.00	120.00	44.1	MLM-120M-120-Z-ECO Mounts - Levelling - Studded - Economy - Plain Base
M12x1.75	60.00	120.00	44.1	MLM-120M-120-S4-ECO Mounts - Levelling - Studded - Economy - Plain Base
M12x1.75 (12 mm)	60.00	80.00	600.0	MLM-120M-080-S4 Mounts - Levelling - Studded - 303 Stainless
M12x1.75 (12 mm)	60.00	100.00	600.0	MLM-120M-100-S4 Mounts - Levelling - Studded - 303 Stainless
M12x1.75 (12 mm)	60.00	150.00	600.0	MLM-120M-150-S4 Mounts - Levelling - Studded - 303 Stainless
M12x1.75 (12 mm)	60.00	150.00	600.0	MLM-120M-150-CZRP Mounts - Levelling - Studded - Plated
M12x1.75 (12 mm)	60.00	100.00	150.0	MLM-120M-100-NYCZ Mounts - Levelling - Studded - Nylon - No Lag Holes
M12x1.75 (12 mm)	60.00	100.00	150.0	MLM-120M-100-NY-S4 Mounts - Levelling - Studded - Nylon - No Lag Holes
M12x1.75 (12 mm)	60.00	120.00	150.0	MLM-120M-120-NYCZ Mounts - Levelling - Studded - Nylon - No Lag Holes
M12x1.75 (12 mm)	60.00	120.00	150.0	MLM-120M-120-NY-S4 Mounts - Levelling - Studded - Nylon - No Lag Holes
M12x1.75 (12 mm)	60.00	100.00	100.0	MLM-120M-100-NYCZRP Mounts - Levelling - Studded - Nylon - No Lag Holes
M12x1.75 (12 mm)	60.00	100.00	100.0	MLM-120M-100-NYCZNE Mounts - Levelling - Studded - Nylon - No Lag Holes
M12x1.75 (12 mm)	60.00	120.00	100.0	MLM-120M-120-NYCZNE Mounts - Levelling - Studded - Nylon - No Lag Holes
M12x1.75 (12 mm)	60.00	120.00	100.0	MLM-120M-120-NYCZRP Mounts - Levelling - Studded - Nylon - No Lag Holes
M12x1.75 (12 mm)	60.00	80.00	210.0	MLM-120M-080-S4NY-0LH Mounts - Levelling - Studded - Nylon - No Lag Holes
M12x1.75 (12 mm)	60.00	80.00	210.0	MLM-120M-080-S4NPRP Mounts - Levelling - Studded - Nylon - No Lag Holes
M12x1.75 (12 mm)	60.00	80.00	210.0	MLM-120M-080-CNY-0LH Mounts - Levelling - Studded - Nylon - No Lag Holes
M12x1.75 (12 mm)	60.00	80.00	600.0	MSM-120M-080-S4RP Mounts - Levelling - Studded - 303 Stainless - Swivel - Rubber Padded
M12x1.75 (12 mm)	60.00	80.00	600.0	MSM-120M-080-CZRP Mounts - Levelling - Studded - 303 Stainless - Swivel - Rubber Padded
M12x1.75 (12 mm)	60.00	100.00	210.0	MLM-120M-100-CNY-0LH Mounts - Levelling - Studded - Nylon - No Lag Holes
M12x1.75 (12 mm)	60.00	100.00	210.0	MLM-120M-100-S4NY-0LH Mounts - Levelling - Studded - Nylon - No Lag Holes
M12x1.75 (12 mm)	60.00	100.00	210.0	MLM-120M-100-S4NPRP Mounts - Levelling - Studded - Nylon - No Lag Holes



Usually stocked or Short Delivery
 ** Available while stocks last **

Long Delivery or Large Minimum Quantities
 Not in current production

Studded Type



Thread Size (A)	Base Diameter (D) mm (in.)	Thread Length (F) mm (in.)	Load Rating Kg	Part Number
Thread Size (A) M12x1.75 (12 mm)				
M12x1.75 (12 mm)	60.00	100.00	600.0	MSM-120M-100-CZRP Mounts - Levelling - Studded - 303 Stainless - Swivel - Rubber Padded
M12x1.75 (12 mm)	60.00	100.00	600.0	MSM-120M-100-S4RP Mounts - Levelling - Studded - 303 Stainless - Swivel - Rubber Padded
M12x1.75 (12 mm)	60.00	120.00	210.0	MLM-120M-120-S4NY-0LH Mounts - Levelling - Studded - Nylon - No Lag Holes
M12x1.75 (12 mm)	60.00	120.00	210.0	MLM-120M-120-S4NPRP Mounts - Levelling - Studded - Nylon - No Lag Holes
M12x1.75 (12 mm)	60.00	120.00	210.0	MLM-120M-120-CNY-0LH Mounts - Levelling - Studded - Nylon - No Lag Holes
M12x1.75 (12 mm)	60.00	120.00	600.0	MSM-120M-120-CZRP Mounts - Levelling - Studded - 303 Stainless - Swivel - Rubber Padded
M12x1.75 (12 mm)	60.00	120.00	600.0	MSM-120M-120-S4RP Mounts - Levelling - Studded - 303 Stainless - Swivel - Rubber Padded
M12x1.75 (12 mm)	60.00	120.00	600.0	MLM-120M-120-CZRP Mounts - Levelling - Studded - Plated - Swivel - Rubber Padded
M12x1.75	60.00	100.00	58.8	MLM-120M-100-ZPP-ECO Mounts - Levelling - Studded - Economy - PVC Padded
M12x1.75	60.00	100.00	58.8	MLM-120M-100-S4PP-ECO Mounts - Levelling - Studded - Economy - PVC Padded
M12x1.75	60.00	120.00	58.8	MLM-120M-120-ZPP-ECO Mounts - Levelling - Studded - Economy - PVC Padded
M12x1.75	60.00	120.00	58.8	MLM-120M-120-S4PP-ECO Mounts - Levelling - Studded - Economy - PVC Padded
M12x1.75	70.00	80.00	34.3	MLM-120M-080-ZRP-ECO Mounts - Levelling - Studded - Economy - Rubber Padded
M12x1.75	70.00	100.00	36.3	MLM-120M-100-ZRP-ECO Mounts - Levelling - Studded - Economy - Rubber Padded
M12x1.75	70.00	120.00	38.2	MLM-120M-120-ZRP-ECO Mounts - Levelling - Studded - Economy - Rubber Padded
M12x1.75 (12 mm)	76.20	51.00	47.0	MLM-120M-051-C-AVLD Mounts - Levelling - Studded - Anti-Vibration
M12x1.75 (12 mm)	76.20	51.00	90.0	MLM-120M-051-C-AVMD Mounts - Levelling - Studded - Anti-Vibration
M12x1.75 (12 mm)	76.20	51.00	188.0	MLM-120M-051-C-AVHD Mounts - Levelling - Studded - Anti-Vibration
M12x1.75 (12 mm)	76.20	84.00	47.0	MLM-120M-084-C-AVLD Mounts - Levelling - Studded - Anti-Vibration
M12x1.75 (12 mm)	76.20	84.00	90.0	MLM-120M-084-C-AVMD Mounts - Levelling - Studded - Anti-Vibration
M12x1.75 (12 mm)	80.00	45.00	100.0	MLM-120M-045-TP-2LH Mounts - Levelling - Studded - Thermoplastic
M12x1.75 (12 mm)	80.00	70.00	100.0	MLM-120M-070-TP-080 Mounts - Levelling - Studded - Thermoplastic
M12x1.75 (12 mm)	80.00	70.00	100.0	MLM-120M-070-TP-2LH Mounts - Levelling - Studded - Thermoplastic
Thread Size (A) 1/2-13 UNC (12.7 mm)				
1/2-13 UNC (12.7 mm)	39.10	47.80	315.0	MLM-127C-048-CNY-0LH Mounts - Levelling - Studded - Nylon - No Lag Holes
1/2-13 UNC (12.7 mm)	39.10	73.20	315.0	MLM-127C-073-CNY-0LH Mounts - Levelling - Studded - Nylon - No Lag Holes
1/2-13 UNC (12.7 mm)	47.60	50.80	2270.0	MLM-127C-051-S3 Mounts - Levelling - Studded - 303 Stainless
1/2-13 UNC (12.7 mm)	47.60	50.80	2270.0	MSM-127C-051-S3 Mounts - Levelling - Studded - 303 Stainless - Swivel
1/2-13 UNC (12.7 mm)	47.60	50.80	2270.0	MLM-127C-051-CBC Mounts - Levelling - Studded - Black Chromate



 Usually stocked or Short Delivery
 ** Available while stocks last **

 Long Delivery or Large Minimum Quantities
 Not in current production

Studded Type



Thread Size (A)	Base Diameter (D) mm (in.)	Thread Length (F) mm (in.)	Load Rating Kg	Part Number
Thread Size (A) 1/2-13 UNC (12.7 mm)				
1/2-13 UNC (12.7 mm)	47.60	50.80	2270.0	MSM-127C-051-CBC Mounts - Levelling - Studded - Black Chromate - Swivel
1/2-13 UNC (12.7 mm)	47.60	50.80	2270.0	MSM-127C-051-CCC Mounts - Levelling - Studded - Clear Chromate - Swivel
1/2-13 UNC (12.7 mm)	47.60	50.80	2270.0	MLM-127C-051-CGC Mounts - Levelling - Studded - Gold Chromate
1/2-13 UNC (12.7 mm)	47.60	50.80	2270.0	MSM-127C-051-CGC Mounts - Levelling - Studded - Gold Chromate - Swivel
1/2-20 UNF (12.7 mm)	47.60	50.80	2270.0	MSM-127F-051-CGC Mounts - Levelling - Studded - Gold Chromate - Swivel
1/2-13 UNC (12.7 mm)	47.60	50.80	2270.0	MLM-127C-051-CNP Mounts - Levelling - Studded - Plated
1/2-10 (12.7 mm)	47.60	50.80	3400.0	MLM-127A-051-CGC Mounts - Levelling - Studded - Acme Thread - Gold Chromate
1/2-13 UNC (12.7 mm)	47.60	101.60	2270.0	MLM-127C-102-S3 Mounts - Levelling - Studded - 303 Stainless
1/2-13 UNC (12.7 mm)	47.60	101.60	2270.0	MSM-127C-102-S3 Mounts - Levelling - Studded - 303 Stainless - Swivel
1/2-13 UNC (12.7 mm)	47.60	101.60	2270.0	MSM-127C-102-S6 Mounts - Levelling - Studded - 316 Stainless - Swivel
1/2-13 UNC (12.7 mm)	47.60	101.60	2270.0	MSM-127C-102-CBC Mounts - Levelling - Studded - Black Chromate - Swivel
1/2-13 UNC (12.7 mm)	47.60	101.60	2270.0	MSM-127C-102-CCC Mounts - Levelling - Studded - Clear Chromate - Swivel
1/2-13 UNC (12.7 mm)	47.60	101.60	2270.0	MLM-127C-102-CGC Mounts - Levelling - Studded - Gold Chromate
1/2-13 UNC (12.7 mm)	47.60	101.60	2270.0	MSM-127C-102-CGC Mounts - Levelling - Studded - Gold Chromate - Swivel
1/2-13 UNC (12.7 mm)	47.60	101.60	2270.0	MLM-127C-102-CNP Mounts - Levelling - Studded - Plated
1/2-13 UNC (12.7 mm)	47.60	50.80	1700.0	MSM-127C-051-S3RP Mounts - Levelling - Studded - 303 Stainless - Swivel - Rubber Padded
1/2-13 UNC (12.7 mm)	47.60	50.80	1700.0	MSM-127C-051-CBCRP Mounts - Levelling - Studded - Black Chromate - Swivel - Rubber Padded
1/2-13 UNC (12.7 mm)	47.60	50.80	1700.0	MSM-127C-051-CGCRP Mounts - Levelling - Studded - Gold Chromate - Swivel - Rubber Padded
1/2-13 UNC (12.7 mm)	47.60	50.80	1750.0	MSM-127C-051-CNPRP Mounts - Levelling - Studded - Plated - Swivel - Rubber Padded
1/2-13 UNC (12.7 mm)	47.60	101.60	315.0	MSM-127C-102-CGCAB Mounts - Levelling - Studded - Gold Chromate - Swivel - Acetal Base
1/2-13 UNC (12.7 mm)	47.60	101.60	1560.0	MSM-127C-102-S3RP Mounts - Levelling - Studded - 303 Stainless - Swivel - Rubber Padded
1/2-13 UNC (12.7 mm)	47.60	101.60	1700.0	MSM-127C-102-S6RP Mounts - Levelling - Studded - 316 Stainless - Swivel - Rubber Padded
1/2-13 UNC (12.7 mm)	47.60	101.60	1700.0	MSM-127C-102-CBCRP Mounts - Levelling - Studded - Black Chromate - Swivel - Rubber Padded
1/2-13 UNC (12.7 mm)	47.60	101.60	1700.0	MSM-127C-102-CGCRP Mounts - Levelling - Studded - Gold Chromate - Swivel - Rubber Padded
1/2-13 UNC (12.7 mm)	47.60	101.60	1730.0	MSM-127C-102-CCCRP Mounts - Levelling - Studded - Clear Chromate - Swivel - Rubber Padded
1/2-13 UNC (12.7 mm)	50.80	50.80	140.0	MLM-127C-051-CNP-LD Mounts - Levelling - Studded - Light Duty - Nylon Padded
1/2-13 UNC (12.7 mm)	50.80	50.80	140.0	MLM-127C-051-C-LDRP Mounts - Levelling - Studded - Light Duty - Rubber Padded
1/2-13 UNC (12.7 mm)	59.90	101.60	500.0	MLM-127C-102-S4HY Mounts - Levelling - Studded - Hygienic - 304 Stainless
1/2-13 UNC (12.7 mm)	59.90	152.40	500.0	MLM-127C-152-S4HY-060 Mounts - Levelling - Studded - Hygienic - 304 Stainless



 Usually stocked or Short Delivery
 ** Available while stocks last **

 Long Delivery or Large Minimum Quantities
 Not in current production

Studded Type



Thread Size (A)	Base Diameter (D) mm (in.)	Thread Length (F) mm (in.)	Load Rating Kg	Part Number
Thread Size (A) 1/2-13 UNC (12.7 mm)				
1/2-13 UNC (12.7 mm)	61.00	50.80	110.0	MLM-127C-051-S3NP-I-061 Mounts - Levelling - Studded - 303 Stainless - Industrial - Nylon Padded
1/2-13 UNC (12.7 mm)	61.00	50.80	110.0	MLM-127C-051-CNP-I-061 Mounts - Levelling - Studded - Industrial - Nylon Padded
1/2-13 UNC (12.7 mm)	61.00	50.80	110.0	MLM-127C-051-CRP-I-061 Mounts - Levelling - Studded - Industrial - Rubber Padded
1/2-13 UNC (12.7 mm)	61.00	101.60	110.0	MLM-127C-102-S3RP-I-061 Mounts - Levelling - Studded - 303 Stainless - Industrial - Rubber Padded
1/2-13 UNC (12.7 mm)	61.00	101.60	110.0	MLM-127C-102-CNP-I-061 Mounts - Levelling - Studded - Industrial - Nylon Padded
3/8-16 UNC (9.53 mm)	61.00	101.60	110.0	MLM-095C-102-CNP-I Mounts - Levelling - Studded - Industrial - Nylon Padded
1/2-13 UNC (12.7 mm)	61.00	101.60	110.0	MLM-127C-102-CRP-I-061 Mounts - Levelling - Studded - Industrial - Rubber Padded
1/2-13 UNC (12.7 mm)	71.10	50.80	230.0	MLM-127C-051-S3NP-I-071 Mounts - Levelling - Studded - 303 Stainless - Industrial - Nylon Padded
1/2-13 UNC (12.7 mm)	71.10	50.80	230.0	MLM-127C-051-S3RP-I Mounts - Levelling - Studded - 303 Stainless - Industrial - Rubber Padded
1/2-13 UNC (12.7 mm)	71.10	50.80	230.0	MLM-127C-051-CNP-I-071 Mounts - Levelling - Studded - Industrial - Nylon Padded
1/2-13 UNC (12.7 mm)	71.10	50.80	230.0	MLM-127C-051-CRP-I-071 Mounts - Levelling - Studded - Industrial - Rubber Padded
1/2-13 UNC (12.7 mm)	71.10	101.60	230.0	MLM-127C-102-S3NP-I-071 Mounts - Levelling - Studded - 303 Stainless - Industrial - Nylon Padded
1/2-13 UNC (12.7 mm)	71.10	101.60	230.0	MLM-127C-102-S3RP-I-071 Mounts - Levelling - Studded - 303 Stainless - Industrial - Rubber Padded
1/2-13 UNC (12.7 mm)	71.10	101.60	230.0	MLM-127C-102-CNP-I-071 Mounts - Levelling - Studded - Industrial - Nylon Padded
1/2-13 UNC (12.7 mm)	71.10	101.60	230.0	MLM-127C-102-CRP-I-071 Mounts - Levelling - Studded - Industrial - Rubber Padded
1/2-13 UNC (12.7 mm)	74.90	101.60	800.0	MLM-127C-102-S4-AHY1-075 Mounts - Levelling - Studded - Hygienic - Anchoring - One Mounting Hole
1/2-13 UNC (12.7 mm)	74.90	101.60	800.0	MLM-127C-102-S4-AHY2 Mounts - Levelling - Studded - Hygienic - Anchoring - Two Mounting Hole
1/2-13 UNC (12.7 mm)	74.90	152.40	800.0	MLM-127C-152-S4-AHY1-075 Mounts - Levelling - Studded - Hygienic - Anchoring - One Mounting Hole
1/2-13 UNC (12.7 mm)	74.90	152.40	800.0	MLM-127C-152-S4-AHY2 Mounts - Levelling - Studded - Hygienic - Anchoring - Two Mounting Hole
1/2-13 UNC (12.7 mm)	76.20	50.80	47.0	MLM-127C-051-C-AVLD Mounts - Levelling - Studded - Anti-Vibration
1/2-13 UNC (12.7 mm)	76.20	50.80	90.0	MLM-127C-051-C-AVMD Mounts - Levelling - Studded - Anti-Vibration
1/2-13 UNC (12.7 mm)	76.20	50.80	188.0	MLM-127C-051-C-AVHD Mounts - Levelling - Studded - Anti-Vibration
1/2-13 UNC (12.7 mm)	76.20	101.60	47.0	MLM-127C-102-C-AVLD Mounts - Levelling - Studded - Anti-Vibration
1/2-13 UNC (12.7 mm)	76.20	101.60	90.0	MLM-127C-102-C-AVMD Mounts - Levelling - Studded - Anti-Vibration
1/2-13 UNC (12.7 mm)	76.20	101.60	188.0	MLM-127C-102-C-AVHD Mounts - Levelling - Studded - Anti-Vibration
1/2-13 UNC (12.7 mm)	78.70	61.50	900.0	MLM-127C-061-S3NY-0LH Mounts - Levelling - Studded - Nylon - No Lag Holes
1/2-13 UNC (12.7 mm)	78.70	61.50	900.0	MLM-127C-062-CNY-0LH Mounts - Levelling - Studded - Nylon - No Lag Holes
1/2-13 UNC (12.7 mm)	78.70	61.50	900.0	MLM-127C-062-S3NY-2LH Mounts - Levelling - Studded - Nylon - With Lag Holes
1/2-13 UNC (12.7 mm)	78.70	61.50	900.0	MLM-127C-062-CNY-2LH Mounts - Levelling - Studded - Nylon - With Lag Holes



 Usually stocked or Short Delivery
 ** Available while stocks last **

 Long Delivery or Large Minimum Quantities
 Not in current production

Studded Type

Thread Size (A)	Base Diameter (D) mm (in.)	Thread Length (F) mm (in.)	Load Rating Kg	Part Number
Thread Size (A) 1/2-13 UNC (12.7 mm)				
1/2-13 UNC (12.7 mm)	78.70	125.00	900.0	MLM-127C-125-CNY-0LH Mounts - Levelling - Studded - Nylon - No Lag Holes
1/2-13 UNC (12.7 mm)	78.70	125.00	900.0	MLM-127C-125-S3NY-0LH Mounts - Levelling - Studded - Nylon - No Lag Holes
1/2-13 UNC (12.7 mm)	78.70	125.00	900.0	MLM-127C-125-CNY-2LH Mounts - Levelling - Studded - Nylon - With Lag Holes
1/2-13 UNC (12.7 mm)	78.70	125.00	900.0	MLM-127C-125-S3NY-2LH Mounts - Levelling - Studded - Nylon - With Lag Holes
1/2-13 UNC (12.7 mm)	80.00	101.60	1000.0	MLM-127C-102-S4HY-080 Mounts - Levelling - Studded - Hygienic - 304 Stainless
1/2-13 UNC (12.7 mm)	80.00	152.40	1000.0	MLM-127C-152-S4HY-080 Mounts - Levelling - Studded - Hygienic - 304 Stainless
1/2-13 UNC (12.7 mm)	81.00	101.60	230.0	MLM-127C-102-S3NP-I-081 Mounts - Levelling - Studded - 303 Stainless - Industrial - Nylon Padded
1/2-13 UNC (12.7 mm)	81.00	101.60	230.0	MLM-127C-102-CNP-I-081 Mounts - Levelling - Studded - Industrial - Nylon Padded
1/2-13 UNC (12.7 mm)	81.00	101.60	230.0	MLM-127C-102-CRP-I-081 Mounts - Levelling - Studded - Industrial - Rubber Padded
1/2-13 UNC (12.7 mm)	81.00	152.40	230.0	MLM-127C-152-S3RP-I Mounts - Levelling - Studded - 303 Stainless - Industrial - Rubber Padded
1/2-13 UNC (12.7 mm)	81.00	152.40	230.0	MLM-127C-152-CNP-I Mounts - Levelling - Studded - Industrial - Nylon Padded
1/2-13 UNC (12.7 mm)	81.00	152.40	230.0	MLM-127C-152-CRP-I Mounts - Levelling - Studded - Industrial - Rubber Padded
1/2-13 UNC (12.7 mm)	89.90	101.60	6030.0	MSM-127C-102-S4-ALPHY-H090 Mounts - Levelling - Studded - Hygienic - Anchoring - Low Profile High Swivel
1/2-13 UNC (12.7 mm)	89.90	101.60	6030.0	MSM-127C-102-S4-ALPHY-L090 Mounts - Levelling - Studded - Hygienic - Anchoring - Low Profile Low Swivel
1/2-13 UNC (12.7 mm)	89.90	152.40	6030.0	MSM-127C-152-S4-ALPHY-H090 Mounts - Levelling - Studded - Hygienic - Anchoring - Low Profile High Swivel
1/2-13 UNC (12.7 mm)	100.10	101.60	1000.0	MLM-127C-102-S4-AHY1-100 Mounts - Levelling - Studded - Hygienic - Anchoring - One Mounting Hole
1/2-13 UNC (12.7 mm)	100.10	152.40	1000.0	MLM-127C-152-S4-AHY1-100 Mounts - Levelling - Studded - Hygienic - Anchoring - One Mounting Hole
1/2-13 UNC (12.7 mm)	100.10	101.60	1500.0	MLM-127C-102-S4HY-100 Mounts - Levelling - Studded - Hygienic - 304 Stainless
1/2-13 UNC (12.7 mm)	100.10	152.40	1500.0	MLM-127C-152-S4HY Mounts - Levelling - Studded - Hygienic - 304 Stainless
1/2-13 UNC (12.7 mm)	110.00	101.60	6030.0	MLM-6030-102B-127C-S4-H-110 Mounts - Levelling - Studded - Hygienic - Anchoring - Low Profile High Swivel
1/2-13 UNC (12.7 mm)	110.00	101.60	6030.0	MSM-127C-102-S4-ALPHY-L110 Mounts - Levelling - Studded - Hygienic - Anchoring - Low Profile Low Swivel
1/2-13 UNC (12.7 mm)	110.00	152.40	6030.0	MSM-127C-152-S4-ALPHY-H110 Mounts - Levelling - Studded - Hygienic - Anchoring - Low Profile High Swivel
1/2-13 UNC (12.7 mm)	110.00	152.40	6030.0	MSM-127C-152-S4-ALPHY-L110 Mounts - Levelling - Studded - Hygienic - Anchoring - Low Profile Low Swivel
1/2-13 UNC (12.7 mm)	120.70	127.00	450.0	MLM-127C-127-CEB-OSHAY-121 Mounts - Levelling - Studded - Elastomer Base - OSHA Yellow
1/2-13 UNC (12.7 mm)	120.70	203.20	450.0	MLM-127C-203-CEB-OSHAY Mounts - Levelling - Studded - Elastomer Base - OSHA Yellow
1/2-13 UNC (12.7 mm)	160.30	127.00	1900.0	MLM-127C-127-CEB-OSHAY-160 Mounts - Levelling - Studded - Elastomer Base - OSHA Yellow
1/2-13 UNC (12.7 mm)	184.20	127.00	4500.0	MLM-127C-127-CEB-OSHAY-184 Mounts - Levelling - Studded - Elastomer Base - OSHA Yellow
Thread Size (A) M14x2 (14 mm)				
M14x2 (14 mm)	80.00	70.00	100.0	MLM-140M-070-TP-080 Mounts - Levelling - Studded - Thermoplastic

 Usually stocked or Short Delivery
 ** Available while stocks last **

 Long Delivery or Large Minimum Quantities
 Not in current production

Studded Type



Thread Size (A)	Base Diameter (D) mm (in.)	Thread Length (F) mm (in.)	Load Rating Kg	Part Number
Thread Size (A) M14x2 (14 mm)				
M14x2 (14 mm)	80.00	70.00	100.0	MLM-140M-070-TP-2LH Mounts - Levelling - Studded - Thermoplastic
M14x2 (14 mm)	80.00	120.00	100.0	MLM-140M-120-TP Mounts - Levelling - Studded - Thermoplastic
M14x2 (14 mm)	80.00	120.00	100.0	MLM-140M-120-TP-2LH Mounts - Levelling - Studded - Thermoplastic
Thread Size (A) 5/8-11 UNC (15.88 mm)				
5/8-11 UNC (15.88 mm)	39.10	47.80	315.0	MLM-159C-048-S3NY-0LH Mounts - Levelling - Studded - Nylon - No Lag Holes
5/8-11 UNC (15.88 mm)	39.10	73.20	315.0	MLM-159C-073-CNY-0LH Mounts - Levelling - Studded - Nylon - No Lag Holes
5/8-11 UNC (15.88 mm)	58.40	150.40	900.0	MLM-159C-150-S3NY-LA0LH-058 Mounts - Levelling - Studded - Nylon - Loc-A-Lign - No Lag Holes
5/8-11 UNC (15.88 mm)	59.90	152.40	500.0	MLM-159C-152-S4HY-060 Mounts - Levelling - Studded - Hygienic - 304 Stainless
5/8-11 UNC (15.88 mm)	59.90	203.20	500.0	MLM-159C-203-S4HY-060 Mounts - Levelling - Studded - Hygienic - 304 Stainless
5/8-11 UNC (15.88 mm)	63.50	50.80	2720.0	MLM-159C-051-S3 Mounts - Levelling - Studded - 303 Stainless
5/8-11 UNC (15.88 mm)	63.50	50.80	2720.0	MSM-159C-051-S3 Mounts - Levelling - Studded - 303 Stainless - Swivel
5/8-11 UNC (15.88 mm)	63.50	50.80	2720.0	MLM-159C-051-CBC Mounts - Levelling - Studded - Black Chromate
5/8-11 UNC (15.88 mm)	63.50	50.80	2720.0	MSM-159C-051-CBC Mounts - Levelling - Studded - Black Chromate - Swivel
5/8-11 UNC (15.88 mm)	63.50	50.80	2720.0	MSM-159C-051-CCC Mounts - Levelling - Studded - Clear Chromate - Swivel
5/8-11 UNC (15.88 mm)	63.50	50.80	2720.0	MLM-159C-051-CGC Mounts - Levelling - Studded - Gold Chromate
5/8-11 UNC (15.88 mm)	63.50	50.80	2720.0	MSM-159C-051-CGC Mounts - Levelling - Studded - Gold Chromate - Swivel
5/8-18 UNF (15.88 mm)	63.50	50.80	2720.0	MSM-159F-051-CGC Mounts - Levelling - Studded - Gold Chromate - Swivel
5/8-11 UNC (15.88 mm)	63.50	50.80	2720.0	MLM-159C-051-CNP Mounts - Levelling - Studded - Plated
5/8-11 UNC (15.88 mm)	63.50	50.80	2720.0	MSM-159C-051-CNP Mounts - Levelling - Studded - Plated - Swivel
5/8-11 UNC (15.88 mm)	63.50	101.60	2720.0	MLM-159C-102-S3 Mounts - Levelling - Studded - 303 Stainless
5/8-11 UNC (15.88 mm)	63.50	101.60	2720.0	MSM-159C-102-S3 Mounts - Levelling - Studded - 303 Stainless - Swivel
5/8-11 UNC (15.88 mm)	63.50	101.60	2720.0	MSM-159C-102-CBC Mounts - Levelling - Studded - Black Chromate - Swivel
5/8-11 UNC (15.88 mm)	63.50	101.60	2720.0	MSM-159C-102-CCC Mounts - Levelling - Studded - Clear Chromate - Swivel
5/8-11 UNC (15.88 mm)	63.50	101.60	2720.0	MLM-159C-102-CGC Mounts - Levelling - Studded - Gold Chromate
5/8-11 UNC (15.88 mm)	63.50	101.60	2720.0	MSM-159C-102-CGC Mounts - Levelling - Studded - Gold Chromate - Swivel
5/8-11 UNC (15.88 mm)	63.50	101.60	2720.0	MLM-159C-102-CNP Mounts - Levelling - Studded - Plated
5/8-11 UNC (15.88 mm)	63.50	101.60	2720.0	MSM-159C-102-CNP Mounts - Levelling - Studded - Plated - Swivel
5/8-8 (15.88 mm)	63.50	101.60	4080.0	MLM-159A-102-CGC Mounts - Levelling - Studded - Acme Thread - Gold Chromate
5/8-11 UNC (15.88 mm)	63.50	50.80	2040.0	MSM-159C-051-S3RP Mounts - Levelling - Studded - 303 Stainless - Swivel - Rubber Padded



Usually stocked or Short Delivery
 ** Available while stocks last **

Long Delivery or Large Minimum Quantities
 Not in current production

Studded Type



Thread Size (A)	Base Diameter (D) mm (in.)	Thread Length (F) mm (in.)	Load Rating Kg	Part Number
Thread Size (A) 5/8-11 UNC (15.88 mm)				
5/8-11 UNC (15.88 mm)	63.50	50.80	2040.0	MSM-159C-051-CBCRP Mounts - Levelling - Studded - Black Chromate - Swivel - Rubber Padded
5/8-11 UNC (15.88 mm)	63.50	50.80	2040.0	MSM-159C-051-CGCRP Mounts - Levelling - Studded - Gold Chromate - Swivel - Rubber Padded
5/8-11 UNC (15.88 mm)	63.50	50.80	2100.0	MSM-159C-051-CCCRP Mounts - Levelling - Studded - Clear Chromate - Swivel - Rubber Padded
5/8-11 UNC (15.88 mm)	63.50	101.60	2040.0	MSM-159C-102-CBCRP Mounts - Levelling - Studded - Black Chromate - Swivel - Rubber Padded
5/8-11 UNC (15.88 mm)	63.50	101.60	2040.0	MSM-159C-102-CGCRP Mounts - Levelling - Studded - Gold Chromate - Swivel - Rubber Padded
5/8-11 UNC (15.88 mm)	63.50	101.60	2100.0	MSM-159C-102-CCCRP Mounts - Levelling - Studded - Clear Chromate - Swivel - Rubber Padded
5/8-11 UNC (15.88 mm)	71.10	50.80	230.0	MLM-159C-051-S3NP-I Mounts - Levelling - Studded - 303 Stainless - Industrial - Nylon Padded
5/8-11 UNC (15.88 mm)	71.10	50.80	230.0	MLM-159C-051-CNP-I Mounts - Levelling - Studded - Industrial - Nylon Padded
5/8-11 UNC (15.88 mm)	71.10	101.60	230.0	MLM-159C-102-S3RP-I-071 Mounts - Levelling - Studded - 303 Stainless - Industrial - Rubber Padded
5/8-11 UNC (15.88 mm)	71.10	101.60	230.0	MLM-159C-102-CNP-I Mounts - Levelling - Studded - Industrial - Nylon Padded
5/8-11 UNC (15.88 mm)	71.10	101.60	230.0	MLM-159C-102-CRP-I-071 Mounts - Levelling - Studded - Industrial - Rubber Padded
5/8-11 UNC (15.88 mm)	74.90	152.40	800.0	MLM-159C-152-S4-AHY1-075 Mounts - Levelling - Studded - Hygienic - Anchoring - One Mounting Hole
5/8-11 UNC (15.88 mm)	74.90	152.40	800.0	MLM-159C-152-S4-AHY2 Mounts - Levelling - Studded - Hygienic - Anchoring - Two Mounting Hole
5/8-11 UNC (15.88 mm)	74.90	203.20	800.0	MLM-159C-203-S4-AHY1-075 Mounts - Levelling - Studded - Hygienic - Anchoring - One Mounting Hole
5/8-11 UNC (15.88 mm)	74.90	203.20	800.0	MLM-159C-203-S4-AHY2 Mounts - Levelling - Studded - Hygienic - Anchoring - Two Mounting Hole
5/8-11 UNC (15.88 mm)	78.70	124.90	900.0	MLM-159C-125-S3NY-2LH Mounts - Levelling - Studded - Nylon - With Lag Holes
5/8-11 UNC (15.88 mm)	78.70	124.90	900.0	MLM-159C-125-CNY-2LH Mounts - Levelling - Studded - Nylon - With Lag Holes
5/8-11 UNC (15.88 mm)	78.70	125.00	900.0	MLM-159C-125-S3NY-0LH Mounts - Levelling - Studded - Nylon - No Lag Holes
5/8-11 UNC (15.88 mm)	78.70	125.00	900.0	MLM-159C-125-CNY-0LH Mounts - Levelling - Studded - Nylon - No Lag Holes
5/8-11 UNC (15.88 mm)	80.00	152.40	1000.0	MLM-159C-152-S4HY-080 Mounts - Levelling - Studded - Hygienic - 304 Stainless
5/8-11 UNC (15.88 mm)	80.00	203.20	1000.0	MLM-159C-203-S4HY-080 Mounts - Levelling - Studded - Hygienic - 304 Stainless
5/8-11 UNC (15.88 mm)	81.00	101.60	230.0	MLM-159C-102-S3NP-I Mounts - Levelling - Studded - 303 Stainless - Industrial - Nylon Padded
5/8-11 UNC (15.88 mm)	81.00	101.60	230.0	MLM-159C-102-S3RP-I-081 Mounts - Levelling - Studded - 303 Stainless - Industrial - Rubber Padded
5/8-11 UNC (15.88 mm)	81.00	101.60	230.0	MLM-159C-102-CRP-I-081 Mounts - Levelling - Studded - Industrial - Rubber Padded
5/8-11 UNC (15.88 mm)	81.00	152.40	230.0	MLM-159C-152-S3NP-I Mounts - Levelling - Studded - 303 Stainless - Industrial - Nylon Padded
5/8-11 UNC (15.88 mm)	81.00	152.40	230.0	MLM-159C-152-S3RP-I Mounts - Levelling - Studded - 303 Stainless - Industrial - Rubber Padded
5/8-11 UNC (15.88 mm)	81.00	152.40	230.0	MLM-159C-152-CNP-I Mounts - Levelling - Studded - Industrial - Nylon Padded
5/8-11 UNC (15.88 mm)	81.00	152.40	230.0	MLM-159C-152-CRP-I Mounts - Levelling - Studded - Industrial - Rubber Padded
5/8-11 UNC (15.88 mm)	100.10	152.40	1000.0	MLM-159C-152-S4-AHY1-100 Mounts - Levelling - Studded - Hygienic - Anchoring - One Mounting Hole



 Usually stocked or Short Delivery
 ** Available while stocks last **

 Long Delivery or Large Minimum Quantities
 Not in current production

Studded Type

Thread Size (A)	Base Diameter (D) mm (in.)	Thread Length (F) mm (in.)	Load Rating Kg	Part Number
Thread Size (A) 5/8-11 UNC (15.88 mm)				
5/8-11 UNC (15.88 mm)	100.10	203.20	1000.0	MLM-159C-203-S4-AHY1-100 Mounts - Levelling - Studded - Hygienic - Anchoring - One Mounting Hole
5/8-11 UNC (15.88 mm)	100.10	152.40	1500.0	MLM-159C-152-S4HY-100 Mounts - Levelling - Studded - Hygienic - 304 Stainless
5/8-11 UNC (15.88 mm)	100.10	203.20	1500.0	MLM-159C-203-S4HY-100 Mounts - Levelling - Studded - Hygienic - 304 Stainless
5/8-11 UNC (15.88 mm)	101.60	150.40	1180.0	MLM-159C-150-S3NY-LA0LH-101 Mounts - Levelling - Studded - Nylon - Loc-A-Lign - No Lag Holes
5/8-11 UNC (15.88 mm)	101.60	150.40	1180.0	MLM-1180-159C-NS3-2LH Mounts - Levelling - Studded - Nylon - Loc-A-Lign - With Lag Holes
Thread Size (A) 5/8-11 UNC (15.88 mm)				
5/8-11 UNC (15.88 mm)	89.90	152.40	6030.0	MSM-159C-152-S4-ALPHY-H090 Mounts - Levelling - Studded - Hygienic - Anchoring - Low Profile High Swivel
5/8-11 UNC (15.88 mm)	89.90	152.40	6030.0	MLM-6030-152B-159C-S4-L-090 Mounts - Levelling - Studded - Hygienic - Anchoring - Low Profile Low Swivel
5/8-11 UNC (15.88 mm)	89.90	203.20	6030.0	MSM-159C-203-S4-ALPHY-H090 Mounts - Levelling - Studded - Hygienic - Anchoring - Low Profile High Swivel
5/8-11 UNC (15.88 mm)	110.00	152.40	6030.0	MSM-159C-152-S4-ALPHY-H110 Mounts - Levelling - Studded - Hygienic - Anchoring - Low Profile High Swivel
5/8-11 UNC (15.88 mm)	110.00	152.40	6030.0	MSM-159C-152-S4-ALPHY-L100 Mounts - Levelling - Studded - Hygienic - Anchoring - Low Profile Low Swivel
5/8-11 UNC (15.88 mm)	110.00	203.20	6030.0	MLM-6030-203A-159C-S4-H-110 Mounts - Levelling - Studded - Hygienic - Anchoring - Low Profile High Swivel
5/8-11 UNC (15.88 mm)	110.00	203.20	6030.0	MSM-159C-203-S4-ALPHY-L110 Mounts - Levelling - Studded - Hygienic - Anchoring - Low Profile Low Swivel
Thread Size (A) M16x2 (16 mm)				
M16x2 (16 mm)	48.80	123.00	315.0	MLM-160M-123-S3NY-0LH Mounts - Levelling - Studded - Nylon - No Lag Holes
M16x2 (16 mm)	58.40	88.00	900.0	MLM-160M-088-S3NY-0LH-058 Mounts - Levelling - Studded - Nylon - No Lag Holes
M16x2 (16 mm)	58.40	168.00	900.0	MLM-160M-168-CNY-0LH-058 Mounts - Levelling - Studded - Nylon - No Lag Holes
M16x2 (16 mm)	60.00	80.00	450.0	MLM-160M-080-S4RP-I Mounts - Levelling - Studded - 303 Stainless - Industrial - Rubber Padded
M16x2 (16 mm)	60.00	80.00	450.0	MLM-160M-080-S4RP Mounts - Levelling - Studded - Black Chromate - Swivel - Rubber Padded
M16x2 (16 mm)	60.00	80.00	450.0	MLM-160M-080-CZRP Mounts - Levelling - Studded - Black Chromate - Swivel - Rubber Padded
M16x2 (16 mm)	60.00	100.00	450.0	MLM-160M-100-S4RP-I Mounts - Levelling - Studded - 303 Stainless - Industrial - Rubber Padded
M16x2 (16 mm)	60.00	100.00	450.0	MLM-160M-100-CZRP Mounts - Levelling - Studded - Black Chromate - Swivel - Rubber Padded
M16x2 (16 mm)	60.00	100.00	450.0	MLM-160M-100-S4RP Mounts - Levelling - Studded - Black Chromate - Swivel - Rubber Padded
M16x2 (16 mm)	60.00	150.00	450.0	MLM-160M-150-S4RP-I Mounts - Levelling - Studded - 303 Stainless - Industrial - Rubber Padded
M16x2 (16 mm)	60.00	150.00	450.0	MLM-160M-150-CZRP Mounts - Levelling - Studded - Black Chromate - Swivel - Rubber Padded
M16x2 (16 mm)	60.00	150.00	450.0	MLM-160M-150-S4RP Mounts - Levelling - Studded - Black Chromate - Swivel - Rubber Padded
M16x2 (16 mm)	60.00	100.00	700.0	MLM-160M-100-S4 Mounts - Levelling - Studded - 303 Stainless
M16x2 (16 mm)	60.00	120.00	700.0	MLM-160M-120-S4 Mounts - Levelling - Studded - 303 Stainless
M16x2 (16 mm)	60.00	150.00	700.0	MLM-160M-150-S4 Mounts - Levelling - Studded - 303 Stainless
M16x2 (16 mm)	60.00	100.00	150.0	MLM-160M-100-NY-S4 Mounts - Levelling - Studded - Nylon - No Lag Holes

 Usually stocked or Short Delivery
 ** Available while stocks last **

 Long Delivery or Large Minimum Quantities
 Not in current production

Studded Type



Thread Size (A)	Base Diameter (D) mm (in.)	Thread Length (F) mm (in.)	Load Rating Kg	Part Number
Thread Size (A) M16x2 (16 mm)				
M16x2 (16 mm)	60.00	100.00	150.0	MLM-160M-100-NYCZ Mounts - Levelling - Studded - Nylon - No Lag Holes
M16x2 (16 mm)	60.00	120.00	150.0	MLM-160M-120-NYCZ Mounts - Levelling - Studded - Nylon - No Lag Holes
M16x2 (16 mm)	60.00	120.00	150.0	MLM-160M-120-NY-S4 Mounts - Levelling - Studded - Nylon - No Lag Holes
M16x2 (16 mm)	60.00	150.00	150.0	MLM-160M-150-NY-S4 Mounts - Levelling - Studded - Nylon - No Lag Holes
M16x2 (16 mm)	60.00	150.00	150.0	MLM-160M-150-NYCZ Mounts - Levelling - Studded - Nylon - No Lag Holes
M16x2 (16 mm)	60.00	100.00	120.0	MLM-160M-100-NYCZRP Mounts - Levelling - Studded - Nylon - No Lag Holes
M16x2 (16 mm)	60.00	100.00	120.0	MLM-160M-100-NYCZNE Mounts - Levelling - Studded - Nylon - No Lag Holes
M16x2 (16 mm)	60.00	120.00	120.0	MLM-160M-120-NYCZRP Mounts - Levelling - Studded - Nylon - No Lag Holes
M16x2 (16 mm)	60.00	120.00	120.0	MLM-160M-120-NYCZNE Mounts - Levelling - Studded - Nylon - No Lag Holes
M16x2 (16 mm)	60.00	150.00	120.0	MLM-160M-150-NYCZRP Mounts - Levelling - Studded - Nylon - No Lag Holes
M16x2 (16 mm)	60.00	150.00	120.0	MLM-160M-150-NYCZNE Mounts - Levelling - Studded - Nylon - No Lag Holes
M16x2 (16 mm)	60.00	100.00	210.0	MLM-160M-100-S4NPRP Mounts - Levelling - Studded - Nylon - No Lag Holes
M16x2 (16 mm)	60.00	100.00	210.0	MLM-160M-100-S4NY-0LH Mounts - Levelling - Studded - Nylon - No Lag Holes
M16x2 (16 mm)	60.00	100.00	210.0	MLM-160M-100-CNY-0LH Mounts - Levelling - Studded - Nylon - No Lag Holes
M16x2 (16 mm)	60.00	100.00	700.0	MSM-160M-100-S4RP Mounts - Levelling - Studded - 303 Stainless - Swivel - Rubber Padded
M16x2 (16 mm)	60.00	100.00	700.0	MSM-160M-100-CZRP Mounts - Levelling - Studded - 303 Stainless - Swivel - Rubber Padded
M16x2 (16 mm)	60.00	120.00	210.0	MLM-160M-120-S4NPRP Mounts - Levelling - Studded - Nylon - No Lag Holes
M16x2 (16 mm)	60.00	120.00	210.0	MLM-160M-120-S4NY-0LH Mounts - Levelling - Studded - Nylon - No Lag Holes
M16x2 (16 mm)	60.00	120.00	210.0	MLM-160M-120-CNY-0LH Mounts - Levelling - Studded - Nylon - No Lag Holes
M16x2 (16 mm)	60.00	120.00	700.0	MSM-160M-120-S4RP Mounts - Levelling - Studded - 303 Stainless - Swivel - Rubber Padded
M16x2 (16 mm)	60.00	120.00	700.0	MSM-160M-120-CZRP Mounts - Levelling - Studded - 303 Stainless - Swivel - Rubber Padded
M16x2 (16 mm)	60.00	150.00	210.0	MLM-160M-150-S4NPRP Mounts - Levelling - Studded - Nylon - No Lag Holes
M16x2 (16 mm)	60.00	150.00	210.0	MLM-160M-150-CNY-0LH Mounts - Levelling - Studded - Nylon - No Lag Holes
M16x2 (16 mm)	60.00	150.00	210.0	MLM-160M-150-S4NY-0LH Mounts - Levelling - Studded - Nylon - No Lag Holes
M16x2 (16 mm)	60.00	150.00	700.0	MSM-160M-150-CZRP Mounts - Levelling - Studded - 303 Stainless - Swivel - Rubber Padded
M16x2 (16 mm)	60.00	150.00	700.0	MSM-160M-150-S4RP Mounts - Levelling - Studded - 303 Stainless - Swivel - Rubber Padded
M16x2.00	60.00	100.00	68.6	MLM-160M-100-ZPP-ECO Mounts - Levelling - Studded - Economy - PVC Padded
M16x2.00	60.00	100.00	68.6	MLM-160M-100-S4PP-ECO Mounts - Levelling - Studded - Economy - PVC Padded
M16x2.00	60.00	120.00	68.6	MLM-160M-120-S4PP-ECO Mounts - Levelling - Studded - Economy - PVC Padded



Usually stocked or Short Delivery
 ** Available while stocks last **

Long Delivery or Large Minimum Quantities
 Not in current production

Studded Type

Thread Size (A)	Base Diameter (D) mm (in.)	Thread Length (F) mm (in.)	Load Rating Kg	Part Number
Thread Size (A) M16x2 (16 mm)				
M16x2.00	60.00	120.00	68.6	MLM-160M-120-ZPP-ECO Mounts - Levelling - Studded - Economy - PVC Padded
M16x2.00	60.00	150.00	68.6	MLM-160M-150-S4PP-ECO Mounts - Levelling - Studded - Economy - PVC Padded
M16x2.00	60.00	150.00	68.6	MLM-160M-150-ZPP-ECO Mounts - Levelling - Studded - Economy - PVC Padded
M16x2 (16 mm)	64.00	51.00	2700.0	MSM-160M-051-CBC Mounts - Levelling - Studded - Black Chromate - Swivel
M16x2 (16 mm)	64.00	51.00	2700.0	MSM-160M-051-CNP Mounts - Levelling - Studded - Plated - Swivel
M16x2 (16 mm)	64.00	51.00	2720.0	MLM-160M-051-S3 Mounts - Levelling - Studded - 303 Stainless
M16x2 (16 mm)	64.00	51.00	2720.0	MSM-160M-051-CCC Mounts - Levelling - Studded - Clear Chromate - Swivel
M16x2 (16 mm)	64.00	51.00	2720.0	MLM-160M-051-CGC Mounts - Levelling - Studded - Gold Chromate
M16x2 (16 mm)	64.00	51.00	2720.0	MSM-160M-051-CGC Mounts - Levelling - Studded - Gold Chromate - Swivel
M16x2 (16 mm)	64.00	51.00	2720.0	MLM-160M-051-CNP Mounts - Levelling - Studded - Plated
M16x2 (16 mm)	64.00	51.00	2040.0	MSM-160M-051-CBCRP Mounts - Levelling - Studded - Black Chromate - Swivel - Rubber Padded
M16x2 (16 mm)	64.00	51.00	2040.0	MSM-160M-051-CGCRP Mounts - Levelling - Studded - Gold Chromate - Swivel - Rubber Padded
M16x2.00	75.00	100.00	53.9	MLM-160M-100-S4-ECO Mounts - Levelling - Studded - Economy - Plain Base
M16x2.00	75.00	100.00	53.9	MLM-160M-100-Z-ECO Mounts - Levelling - Studded - Economy - Plain Base
M16x2.00	75.00	120.00	53.9	MLM-160M-120-S4-ECO Mounts - Levelling - Studded - Economy - Plain Base
M16x2.00	75.00	120.00	53.9	MLM-160M-120-Z-ECO Mounts - Levelling - Studded - Economy - Plain Base
M16x2.00	75.00	150.00	53.9	MLM-160M-150-Z-ECO Mounts - Levelling - Studded - Economy - Plain Base
M16x2.00	75.00	150.00	53.9	MLM-160M-150-S4-ECO Mounts - Levelling - Studded - Economy - Plain Base
M16x2 (16 mm)	78.70	64.00	900.0	MLM-160M-064-CNY-2LH Mounts - Levelling - Studded - Nylon - With Lag Holes
M16x2 (16 mm)	78.70	64.00	900.0	MLM-160M-064-S3NY-2LH Mounts - Levelling - Studded - Nylon - With Lag Holes
M16x2 (16 mm)	78.70	123.00	900.0	MLM-160M-123-S3NY-2LH Mounts - Levelling - Studded - Nylon - With Lag Holes
M16x2 (16 mm)	78.70	123.00	900.0	MLM-160M-123-CNY-2LH Mounts - Levelling - Studded - Nylon - With Lag Holes
M16x2 (16 mm)	80.00	70.00	100.0	MLM-160M-070-TP-080 Mounts - Levelling - Studded - Thermoplastic
M16x2 (16 mm)	80.00	70.00	100.0	MLM-160M-070-TP-2LH Mounts - Levelling - Studded - Thermoplastic
M16x2 (16 mm)	80.00	120.00	100.0	MLM-160M-120-TP-2LH Mounts - Levelling - Studded - Thermoplastic
M16x2 (16 mm)	80.00	120.00	100.0	MLM-160M-120-TP-0LH Mounts - Levelling - Studded - Thermoplastic
M16x2 (16 mm)	80.00	120.00	450.0	MLM-160M-120-S4RP-I Mounts - Levelling - Studded - 303 Stainless - Industrial - Rubber Padded
M16x2 (16 mm)	80.00	120.00	450.0	MLM-160M-120-CZRP Mounts - Levelling - Studded - Black Chromate - Swivel - Rubber Padded
M16x2.00	80.00	100.00	45.1	MLM-160M-100-ZRP-ECO Mounts - Levelling - Studded - Economy - Rubber Padded

 Usually stocked or Short Delivery
 ** Available while stocks last **

 Long Delivery or Large Minimum Quantities
 Not in current production

Studded Type



Thread Size (A)	Base Diameter (D) mm (in.)	Thread Length (F) mm (in.)	Load Rating Kg	Part Number
Thread Size (A) M16x2 (16 mm)				
M16x2.00	80.00	120.00	48.0	MLM-160M-120-ZRP-ECO Mounts - Levelling - Studded - Economy - Rubber Padded
M16x2.00	80.00	150.00	49.0	MLM-160M-150-ZRP-ECO Mounts - Levelling - Studded - Economy - Rubber Padded
M16x2.00	80.00	100.00	68.6	MLM-160M-100-ZPPH-ECO Mounts - Levelling - Studded - Economy - PVC Padded
M16x2.00	80.00	120.00	68.6	MLM-160M-120-ZPPH-ECO Mounts - Levelling - Studded - Economy - PVC Padded
M16x2.00	80.00	150.00	68.6	MLM-160M-150-ZPPH-ECO Mounts - Levelling - Studded - Economy - PVC Padded
M16x2 (16 mm)	97.80	88.00	1170.0	MLM-160M-088-S3NY-0LH-098 Mounts - Levelling - Studded - Nylon - No Lag Holes
M16x2 (16 mm)	97.80	88.00	1170.0	MLM-160M-088-CNY-0LH Mounts - Levelling - Studded - Nylon - No Lag Holes
M16x2 (16 mm)	97.80	88.00	1180.0	MLM-160M-088-CNY-2LH Mounts - Levelling - Studded - Nylon - With Lag Holes
M16x2 (16 mm)	97.80	168.00	1180.0	MLM-160M-168-CNY-2LH Mounts - Levelling - Studded - Nylon - With Lag Holes
M16x2 (16 mm)	97.80	168.00	1180.0	MLM-160M-168-S3NY-2LH Mounts - Levelling - Studded - Nylon - With Lag Holes
Thread Size (A) 3/4-10 UNC (19.1 mm)				
3/4-10 UNC (19.1 mm)	59.90	152.40	500.0	MLM-191C-152-S4HY-060 Mounts - Levelling - Studded - Hygienic - 304 Stainless
3/4-10 UNC (19.1 mm)	59.90	203.20	500.0	MLM-191C-203-S4HY-060 Mounts - Levelling - Studded - Hygienic - 304 Stainless
3/4-10 UNC (19.1 mm)	63.50	101.60	820.0	MSM-191C-102-CGCAB-064 Mounts - Levelling - Studded - Gold Chromate - Swivel - Acetal Base
3/4-10 UNC (19.1 mm)	74.90	152.40	800.0	MLM-191C-152-S4-AHY1-075 Mounts - Levelling - Studded - Hygienic - Anchoring - One Mounting Hole
3/4-10 UNC (19.1 mm)	74.90	152.40	800.0	MLM-191C-152-S4-AHY2 Mounts - Levelling - Studded - Hygienic - Anchoring - Two Mounting Hole
3/4-10 UNC (19.1 mm)	74.90	203.20	800.0	MLM-191C-203-S4-075 Mounts - Levelling - Studded - Hygienic - Anchoring - One Mounting Hole
3/4-10 UNC (19.1 mm)	74.90	203.20	800.0	MLM-191C-203-S4-AHY2 Mounts - Levelling - Studded - Hygienic - Anchoring - Two Mounting Hole
3/4-10 UNC (19.1 mm)	76.20	50.80	3270.0	MSM-191C-051-S3 Mounts - Levelling - Studded - 303 Stainless - Swivel
3/4-10 UNC (19.1 mm)	76.20	50.80	3270.0	MLM-191C-051-CBC Mounts - Levelling - Studded - Black Chromate
3/4-10 UNC (19.1 mm)	76.20	50.80	3270.0	MSM-191C-051-CBC Mounts - Levelling - Studded - Black Chromate - Swivel
3/4-10 UNC (19.1 mm)	76.20	50.80	3270.0	MSM-191C-051-CCC Mounts - Levelling - Studded - Clear Chromate - Swivel
3/4-10 UNC (19.1 mm)	76.20	50.80	3270.0	MLM-191C-051-CGC Mounts - Levelling - Studded - Gold Chromate
3/4-16 UNF (19.1 mm)	76.20	50.80	3270.0	MSM-191F-051-CGC Mounts - Levelling - Studded - Gold Chromate - Swivel
3/4-10 UNC (19.1 mm)	76.20	50.80	3270.0	MSM-191C-051-CGC Mounts - Levelling - Studded - Gold Chromate - Swivel
3/4-10 UNC (19.1 mm)	76.20	50.80	3270.0	MLM-191C-051-CNP Mounts - Levelling - Studded - Plated
3/4-10 UNC (19.1 mm)	76.20	50.80	3270.0	MSM-191C-051-C-2LH Mounts - Levelling - Studded - Swivel - With Lag Holes
3/4-10 UNC (19.1 mm)	76.20	50.80	3350.0	MSM-191C-051-S6 Mounts - Levelling - Studded - 316 Stainless - Swivel
3/4-10 UNC (19.1 mm)	76.20	50.80	3350.0	MSM-191C-051-CNP Mounts - Levelling - Studded - Plated - Swivel



Usually stocked or Short Delivery
 ** Available while stocks last **

Long Delivery or Large Minimum Quantities
 Not in current production

Studded Type



Thread Size (A)	Base Diameter (D) mm (in.)	Thread Length (F) mm (in.)	Load Rating Kg	Part Number
Thread Size (A) 3/4-10 UNC (19.1 mm)				
3/4-10 UNC (19.1 mm)	76.20	101.60	3270.0	MLM-191C-102-S3 Mounts - Levelling - Studded - 303 Stainless
3/4-10 UNC (19.1 mm)	76.20	101.60	3270.0	MSM-191C-102-S3 Mounts - Levelling - Studded - 303 Stainless - Swivel
3/4-10 UNC (19.1 mm)	76.20	101.60	3270.0	MSM-191C-102-CBC Mounts - Levelling - Studded - Black Chromate - Swivel
3/4-10 UNC (19.1 mm)	76.20	101.60	3270.0	MSM-191C-102-CCC Mounts - Levelling - Studded - Clear Chromate - Swivel
3/4-10 UNC (19.1 mm)	76.20	101.60	3270.0	MLM-191C-102-CGC Mounts - Levelling - Studded - Gold Chromate
3/4-10 UNC (19.1 mm)	76.20	101.60	3270.0	MSM-191C-102-CGC Mounts - Levelling - Studded - Gold Chromate - Swivel
3/4-10 UNC (19.1 mm)	76.20	101.60	3270.0	MLM-191C-102-CNP Mounts - Levelling - Studded - Plated
3/4-10 UNC (19.1 mm)	76.20	101.60	3270.0	MSM-191C-102-C-2LH Mounts - Levelling - Studded - Swivel - With Lag Holes
3/4-10 UNC (19.1 mm)	76.20	101.60	3350.0	MSM-191C-102-CNP Mounts - Levelling - Studded - Plated - Swivel
3/4-6 (19.1 mm)	76.20	101.60	5030.0	MLM-191A-102-CGC Mounts - Levelling - Studded - Acme Thread - Gold Chromate
3/4-10 UNC (19.1 mm)	76.20	50.80	2450.0	MSM-191C-051-S3RP Mounts - Levelling - Studded - 303 Stainless - Swivel - Rubber Padded
3/4-10 UNC (19.1 mm)	76.20	50.80	2450.0	MSM-191C-051-CBCRP Mounts - Levelling - Studded - Black Chromate - Swivel - Rubber Padded
3/4-10 UNC (19.1 mm)	76.20	50.80	2450.0	MSM-191C-051-CGCRP Mounts - Levelling - Studded - Gold Chromate - Swivel - Rubber Padded
3/4-10 UNC (19.1 mm)	76.20	101.60	2450.0	MSM-191C-102-S3RP Mounts - Levelling - Studded - 303 Stainless - Swivel - Rubber Padded
3/4-10 UNC (19.1 mm)	76.20	101.60	2450.0	MSM-191C-102-CBCRP Mounts - Levelling - Studded - Black Chromate - Swivel - Rubber Padded
3/4-10 UNC (19.1 mm)	76.20	101.60	2450.0	MSM-191C-102-CGCRP Mounts - Levelling - Studded - Gold Chromate - Swivel - Rubber Padded
3/4-10 UNC (19.1 mm)	76.20	101.60	2520.0	MSM-191C-102-CCCRP Mounts - Levelling - Studded - Clear Chromate - Swivel - Rubber Padded
3/4-10 UNC (19.1 mm)	80.00	152.40	1000.0	MLM-191C-152-S4HY Mounts - Levelling - Studded - Hygienic - 304 Stainless
3/4-10 UNC (19.1 mm)	80.00	203.20	1000.0	MLM-191C-203-S4HY-080 Mounts - Levelling - Studded - Hygienic - 304 Stainless
3/4-10 UNC (19.1 mm)	89.90	152.40	6030.0	MSM-191C-152-S4-ALPHY-H090 Mounts - Levelling - Studded - Hygienic - Anchoring - Low Profile High Swivel
3/4-10 UNC (19.1 mm)	89.90	152.40	6030.0	MLM-6030-152B-191C-S4-L-090 Mounts - Levelling - Studded - Hygienic - Anchoring - Low Profile Low Swivel
3/4-10 UNC (19.1 mm)	89.90	203.20	6030.0	MSM-191C-203-S4-ALPHY-H090 Mounts - Levelling - Studded - Hygienic - Anchoring - Low Profile High Swivel
3/4-10 UNC (19.1 mm)	89.90	203.20	6030.0	MLM-6030-203B-191C-S4-L-090 Mounts - Levelling - Studded - Hygienic - Anchoring - Low Profile Low Swivel
3/4-10 UNC (19.1 mm)	100.10	152.40	1000.0	MLM-191C-152-S4-AHY1-100 Mounts - Levelling - Studded - Hygienic - Anchoring - One Mounting Hole
3/4-10 UNC (19.1 mm)	100.10	203.20	1000.0	MLM-191C-203-S4-AHY1-100 Mounts - Levelling - Studded - Hygienic - Anchoring - One Mounting Hole
3/4-10 UNC (19.1 mm)	100.10	152.40	1500.0	MLM-191C-152-S4HY-100 Mounts - Levelling - Studded - Hygienic - 304 Stainless
3/4-10 UNC (19.1 mm)	100.10	203.20	1500.0	MLM-191C-203-S4HY Mounts - Levelling - Studded - Hygienic - 304 Stainless
3/4-10 UNC (19.1 mm)	101.60	150.40	1180.0	MLM-191C-150-S3NY-LA0LH Mounts - Levelling - Studded - Nylon - Loc-A-Lign - No Lag Holes
3/4-10 UNC (19.1 mm)	101.60	150.40	1180.0	MLM-191C-150-S3NY-LA2LH Mounts - Levelling - Studded - Nylon - Loc-A-Lign - With Lag Holes



 Usually stocked or Short Delivery
 ** Available while stocks last **

 Long Delivery or Large Minimum Quantities
 Not in current production

Studded Type

Thread Size (A)	Base Diameter (D) mm (in.)	Thread Length (F) mm (in.)	Load Rating Kg	Part Number
Thread Size (A) 3/4-10 UNC (19.1 mm)				
3/4-10 UNC (19.1 mm)	101.60	226.60	1180.0	MLM-191C-227-S3NY-LA2LH Mounts - Levelling - Studded - Nylon - Loc-A-Lign - With Lag Holes
3/4-10 UNC (19.1 mm)	110.00	152.40	6030.0	MSM-191C-152-S4-ALPHY-H110 Mounts - Levelling - Studded - Hygienic - Anchoring - Low Profile High Swivel
3/4-10 UNC (19.1 mm)	110.00	152.40	6030.0	MSM-191C-152-S4-ALPHY-L110 Mounts - Levelling - Studded - Hygienic - Anchoring - Low Profile Low Swivel
3/4-10 UNC (19.1 mm)	110.00	203.20	6030.0	MSM-191C-203-S4-ALPHY-H110 Mounts - Levelling - Studded - Hygienic - Anchoring - Low Profile High Swivel
3/4-10 UNC (19.1 mm)	110.00	203.20	6030.0	MSM-191C-203-S4-ALPHY-L110 Mounts - Levelling - Studded - Hygienic - Anchoring - Low Profile Low Swivel
3/4-10 UNC (19.1 mm)	113.80	74.90	1996.0	MLM-191C-075-S3NY-0LH Mounts - Levelling - Studded - Nylon - No Lag Holes
3/4-10 UNC (19.1 mm)	122.90	125.20	4490.0	MLM-191C-125-S3NY-2LH Mounts - Levelling - Studded - Nylon - With Lag Holes
3/4-10 UNC (19.1 mm)	122.90	125.20	4490.0	MLM-191C-125-CNY-2LH Mounts - Levelling - Studded - Nylon - With Lag Holes
3/4-10 UNC (19.1 mm)	122.90	129.00	4490.0	MLM-191C-129-S3NY-2LH Mounts - Levelling - Studded - Nylon - With Lag Holes
3/4-10 UNC (19.1 mm)	160.30	127.00	2000.0	MLM-191C-127-CEB-OSHAY-160 Mounts - Levelling - Studded - Elastomer Base - OSHA Yellow
3/4-10 UNC (19.1 mm)	160.30	203.20	1900.0	MLM-191C-203-CEB-OSHAY-160 Mounts - Levelling - Studded - Elastomer Base - OSHA Yellow
3/4-10 UNC (19.1 mm)	160.30	254.00	1900.0	MLM-191C-254-CEB-OSHAY Mounts - Levelling - Studded - Elastomer Base - OSHA Yellow
3/4-10 UNC (19.1 mm)	184.20	127.00	4500.0	MLM-191C-127-CEB-OSHAY-184 Mounts - Levelling - Studded - Elastomer Base - OSHA Yellow
3/4-10 UNC (19.1 mm)	184.20	203.20	4500.0	MLM-191C-203-CEB-OSHAY-184 Mounts - Levelling - Studded - Elastomer Base - OSHA Yellow
Thread Size (A) M20x2.5 (20 mm)				
M20x2.5 (20 mm)	58.40	168.00	900.0	MLM-200M-168-CNY-0LH Mounts - Levelling - Studded - Nylon - No Lag Holes
M20x2.5 (20 mm)	60.00	100.00	450.0	MLM-200M-100-S4RP-I Mounts - Levelling - Studded - 303 Stainless - Industrial - Rubber Padded
M20x2.5 (20 mm)	60.00	100.00	450.0	MLM-200M-100-S4RP Mounts - Levelling - Studded - Black Chromate - Swivel - Rubber Padded
M20x2.5 (20 mm)	60.00	100.00	450.0	MLM-200M-100-CZRP Mounts - Levelling - Studded - Black Chromate - Swivel - Rubber Padded
M20x2.5 (20 mm)	60.00	120.00	450.0	MLM-200M-120-S4RP-I Mounts - Levelling - Studded - 303 Stainless - Industrial - Rubber Padded
M20x2.5 (20 mm)	60.00	120.00	450.0	MLM-200M-120-CZRP Mounts - Levelling - Studded - Black Chromate - Swivel - Rubber Padded
M20x2.5 (20 mm)	60.00	120.00	450.0	MLM-200M-120-S4RP Mounts - Levelling - Studded - Black Chromate - Swivel - Rubber Padded
M20x2.5 (20 mm)	60.00	100.00	800.0	MLM-200M-100-S4 Mounts - Levelling - Studded - 303 Stainless
M20x2.5 (20 mm)	60.00	120.00	800.0	MLM-200M-120-S4 Mounts - Levelling - Studded - 303 Stainless
M20x2.5 (20 mm)	60.00	150.00	800.0	MLM-200M-150-S4 Mounts - Levelling - Studded - 303 Stainless
M20x2.5 (20 mm)	60.00	200.00	800.0	MLM-200M-200-S4 Mounts - Levelling - Studded - 303 Stainless
M20x2.5 (20 mm)	60.00	120.00	150.0	MLM-200M-120-NYCZ Mounts - Levelling - Studded - Nylon - No Lag Holes
M20x2.5 (20 mm)	60.00	120.00	150.0	MLM-200M-120-NY-S4 Mounts - Levelling - Studded - Nylon - No Lag Holes
M20x2.5 (20 mm)	60.00	150.00	150.0	MLM-200M-150-NY-S4 Mounts - Levelling - Studded - Nylon - No Lag Holes

 Usually stocked or Short Delivery
 ** Available while stocks last **

 Long Delivery or Large Minimum Quantities
 Not in current production

Studded Type



Thread Size (A)	Base Diameter (D) mm (in.)	Thread Length (F) mm (in.)	Load Rating Kg	Part Number
Thread Size (A) M20x2.5 (20 mm)				
M20x2.5 (20 mm)	60.00	150.00	150.0	MLM-200M-150-NYCZ Mounts - Levelling - Studded - Nylon - No Lag Holes
M20x2.5 (20 mm)	60.00	200.00	150.0	MLM-200M-200-NY-S4 Mounts - Levelling - Studded - Nylon - No Lag Holes
M20x2.5 (20 mm)	60.00	200.00	150.0	MLM-200M-200-NYCZ Mounts - Levelling - Studded - Nylon - No Lag Holes
M20x2.5 (20 mm)	60.00	120.00	210.0	MLM-200M-120-S4NPRP Mounts - Levelling - Studded - Nylon - No Lag Holes
M20x2.5 (20 mm)	60.00	120.00	210.0	MLM-200M-120-S4NY-0LH Mounts - Levelling - Studded - Nylon - No Lag Holes
M20x2.5 (20 mm)	60.00	120.00	210.0	MLM-200M-120-CNY-0LH Mounts - Levelling - Studded - Nylon - No Lag Holes
M20x2.5 (20 mm)	60.00	120.00	800.0	MSM-200M-120-CZRP Mounts - Levelling - Studded - 303 Stainless - Swivel - Rubber Padded
M20x2.5 (20 mm)	60.00	120.00	800.0	MSM-200M-120-S4RP Mounts - Levelling - Studded - 303 Stainless - Swivel - Rubber Padded
M20x2.5 (20 mm)	60.00	150.00	210.0	MLM-200M-150-S4NY-0LH Mounts - Levelling - Studded - Nylon - No Lag Holes
M20x2.5 (20 mm)	60.00	150.00	210.0	MLM-200M-150-S4NPRP Mounts - Levelling - Studded - Nylon - No Lag Holes
M20x2.5 (20 mm)	60.00	150.00	210.0	MLM-200M-150-CNY-0LH Mounts - Levelling - Studded - Nylon - No Lag Holes
M20x2.5 (20 mm)	60.00	150.00	800.0	MSM-200M-150-S4RP Mounts - Levelling - Studded - 303 Stainless - Swivel - Rubber Padded
M20x2.5 (20 mm)	60.00	150.00	800.0	MSM-200M-150-CZRP Mounts - Levelling - Studded - 303 Stainless - Swivel - Rubber Padded
M20x2.5 (20 mm)	60.00	200.00	800.0	MSM-200M-200-CZRP Mounts - Levelling - Studded - 303 Stainless - Swivel - Rubber Padded
M20x2.5 (20 mm)	60.00	200.00	800.0	MSM-200M-200-S4RP Mounts - Levelling - Studded - 303 Stainless - Swivel - Rubber Padded
M20x2.50	60.00	120.00	78.4	MLM-200M-120-ZPP-ECO Mounts - Levelling - Studded - Economy - PVC Padded
M20x2.50	60.00	120.00	78.4	MLM-200M-120-S4PP-ECO Mounts - Levelling - Studded - Economy - PVC Padded
M20x2.50	60.00	150.00	78.4	MLM-200M-150-S4PP-ECO Mounts - Levelling - Studded - Economy - PVC Padded
M20x2.50	60.00	150.00	78.4	MLM-200M-150-ZPP-ECO Mounts - Levelling - Studded - Economy - PVC Padded
M20x2.50	60.00	200.00	78.4	MLM-200M-200-ZPP-ECO Mounts - Levelling - Studded - Economy - PVC Padded
M20x2.50	60.00	200.00	78.4	MLM-200M-200-S4PP-ECO Mounts - Levelling - Studded - Economy - PVC Padded
M20x2.50	75.00	120.00	66.6	MLM-200M-120-S4-ECO Mounts - Levelling - Studded - Economy - Plain Base
M20x2.50	75.00	120.00	66.6	MLM-200M-120-Z-ECO Mounts - Levelling - Studded - Economy - Plain Base
M20x2.50	75.00	150.00	66.6	MLM-200M-150-S4-ECO Mounts - Levelling - Studded - Economy - Plain Base
M20x2.50	75.00	150.00	66.6	MLM-200M-150-Z-ECO Mounts - Levelling - Studded - Economy - Plain Base
M20x2.50	75.00	200.00	66.6	MLM-200M-200-S4-ECO Mounts - Levelling - Studded - Economy - Plain Base
M20x2.50	75.00	200.00	66.6	MLM-200M-200-Z-ECO Mounts - Levelling - Studded - Economy - Plain Base
M20x2.5 (20 mm)	76.00	51.00	3270.0	MLM-200M-051-S3 Mounts - Levelling - Studded - 303 Stainless
M20x2.5 (20 mm)	76.00	51.00	3270.0	MSM-200M-051-CBC Mounts - Levelling - Studded - Black Chromate - Swivel



Usually stocked or Short Delivery
 ** Available while stocks last **

Long Delivery or Large Minimum Quantities
 Not in current production

Studded Type



Thread Size (A)	Base Diameter (D) mm (in.)	Thread Length (F) mm (in.)	Load Rating Kg	Part Number
Thread Size (A) M20x2.5 (20 mm)				
M20x2.5 (20 mm)	76.00	51.00	3270.0	MSM-200M-051-CCC Mounts - Levelling - Studded - Clear Chromate - Swivel
M20x2.5 (20 mm)	76.00	51.00	3270.0	MLM-200M-051-CGC Mounts - Levelling - Studded - Gold Chromate
M20x2.5 (20 mm)	76.00	51.00	3270.0	MSM-200M-051-CGC Mounts - Levelling - Studded - Gold Chromate - Swivel
M20x2.5 (20 mm)	76.00	51.00	3270.0	MLM-200M-051-CNP Mounts - Levelling - Studded - Plated
M20x2.5 (20 mm)	76.00	51.00	3350.0	MSM-200M-051-S3 Mounts - Levelling - Studded - 303 Stainless - Swivel
M20x2.5 (20 mm)	76.00	51.00	3350.0	MSM-200M-051-CNP Mounts - Levelling - Studded - Plated - Swivel
M20x2.5 (20 mm)	76.00	51.00	2450.0	MSM-200M-051-CGCRP Mounts - Levelling - Studded - Gold Chromate - Swivel - Rubber Padded
M20x2.5 (20 mm)	80.00	100.00	100.0	MLM-200M-100-TP-2LH Mounts - Levelling - Studded - Thermoplastic
M20x2.5 (20 mm)	80.00	100.00	100.0	MLM-200M-100-TP Mounts - Levelling - Studded - Thermoplastic
M20x2.5 (20 mm)	80.00	150.00	450.0	MLM-200M-150-S4RP-I Mounts - Levelling - Studded - 303 Stainless - Industrial - Rubber Padded
M20x2.5 (20 mm)	80.00	150.00	450.0	MLM-200M-150-CZRP Mounts - Levelling - Studded - Black Chromate - Swivel - Rubber Padded
M20x2.5 (20 mm)	80.00	200.00	450.0	MLM-200M-200-S4RP-I Mounts - Levelling - Studded - 303 Stainless - Industrial - Rubber Padded
M20x2.5 (20 mm)	80.00	200.00	450.0	MLM-200M-200-CZRP Mounts - Levelling - Studded - Black Chromate - Swivel - Rubber Padded
M20x2.50	80.00	150.00	65.7	MLM-200M-150-ZRP-ECO Mounts - Levelling - Studded - Economy - Rubber Padded
M20x2.50	80.00	200.00	75.5	MLM-200M-200-ZRP-ECO Mounts - Levelling - Studded - Economy - Rubber Padded
M20x2.5 (20 mm)	80.00	200.00	210.0	MLM-200M-200-S4NY-0LH Mounts - Levelling - Studded - Nylon - No Lag Holes
M20x2.5 (20 mm)	80.00	200.00	210.0	MLM-200M-200-CNY-0LH Mounts - Levelling - Studded - Nylon - No Lag Holes
M20x2.50	80.00	120.00	78.4	MLM-200M-120-ZPPH-ECO Mounts - Levelling - Studded - Economy - PVC Padded
M20x2.50	80.00	150.00	78.4	MLM-200M-150-ZPPH-ECO Mounts - Levelling - Studded - Economy - PVC Padded
M20x2.50	80.00	200.00	78.4	MLM-200M-200-ZPPH-ECO Mounts - Levelling - Studded - Economy - PVC Padded
M20x2.5 (20 mm)	90.00	150.00	350.0	MLM-200M-150-NYCZNE Mounts - Levelling - Studded - Nylon - No Lag Holes
M20x2.5 (20 mm)	90.00	150.00	350.0	MLM-200M-150-NYCZRP Mounts - Levelling - Studded - Nylon - No Lag Holes
M20x2.5 (20 mm)	90.00	200.00	350.0	MLM-200M-200-NYCZRP Mounts - Levelling - Studded - Nylon - No Lag Holes
M20x2.5 (20 mm)	90.00	200.00	350.0	MLM-200M-200-NYCZNE Mounts - Levelling - Studded - Nylon - No Lag Holes
M20x2.5 (20 mm)	97.80	88.00	1170.0	MLM-200M-088-CNY-0LH Mounts - Levelling - Studded - Nylon - No Lag Holes
M20x2.5 (20 mm)	100.00	120.00	350.0	MLM-200M-120-NYCZRP Mounts - Levelling - Studded - Nylon - No Lag Holes
Thread Size (A) 7/8-9 UNC (22.23 mm)				
7/8-9 UNC (22.23 mm)	59.90	152.40	500.0	MLM-222C-152-S4HY-060 Mounts - Levelling - Studded - Hygienic - 304 Stainless
7/8-9 UNC (22.23 mm)	59.90	203.20	500.0	MLM-222C-203-S4HY-060 Mounts - Levelling - Studded - Hygienic - 304 Stainless



 Usually stocked or Short Delivery
 ** Available while stocks last **

 Long Delivery or Large Minimum Quantities
 Not in current production

Studded Type



Thread Size (A)	Base Diameter (D) mm (in.)	Thread Length (F) mm (in.)	Load Rating Kg	Part Number
Thread Size (A) 7/8-9 UNC (22.23 mm)				
7/8-9 UNC (22.23 mm)	74.90	152.40	800.0	MLM-222C-152-S4-AHY1-075 Mounts - Levelling - Studded - Hygienic - Anchoring - One Mounting Hole
7/8-9 UNC (22.23 mm)	74.90	152.40	800.0	MLM-222C-152-S4-AHY2 Mounts - Levelling - Studded - Hygienic - Anchoring - Two Mounting Hole
7/8-9 UNC (22.23 mm)	74.90	203.20	800.0	MLM-222C-203-S4-AHY1-075 Mounts - Levelling - Studded - Hygienic - Anchoring - One Mounting Hole
7/8-9 UNC (22.23 mm)	74.90	203.20	800.0	MLM-222C-203-S4-AHY2 Mounts - Levelling - Studded - Hygienic - Anchoring - Two Mounting Hole
7/8-9 UNC (22.23 mm)	80.00	152.40	1000.0	MLM-222C-152-S4HY-080 Mounts - Levelling - Studded - Hygienic - 304 Stainless
7/8-9 UNC (22.23 mm)	80.00	203.20	1000.0	MLM-222C-203-S4HY-080 Mounts - Levelling - Studded - Hygienic - 304 Stainless
7/8-9 UNC (22.23 mm)	100.10	152.40	1000.0	MLM-222C-152-S4-AHY1-100 Mounts - Levelling - Studded - Hygienic - Anchoring - One Mounting Hole
7/8-9 UNC (22.23 mm)	100.10	203.20	1000.0	MLM-222C-203-S4-AHY1-100 Mounts - Levelling - Studded - Hygienic - Anchoring - One Mounting Hole
Thread Size (A) 7/8-9 UNC (22.23 mm)				
7/8-9 UNC (22.23 mm)	89.90	152.40	6030.0	MSM-222C-152-S4-ALPHY-H090 Mounts - Levelling - Studded - Hygienic - Anchoring - Low Profile High Swivel
7/8-9 UNC (22.23 mm)	89.90	152.40	6030.0	MLM-6030-152B-222C-S4-L-090 Mounts - Levelling - Studded - Hygienic - Anchoring - Low Profile Low Swivel
7/8-9 UNC (22.23 mm)	89.90	203.20	6030.0	MLM-6030-203B-222C-S4-H-090 Mounts - Levelling - Studded - Hygienic - Anchoring - Low Profile High Swivel
7/8-9 UNC (22.23 mm)	89.90	203.20	6030.0	MSM-222C-203-S4-ALPHY-L090 Mounts - Levelling - Studded - Hygienic - Anchoring - Low Profile Low Swivel
7/8-9 UNC (22.23 mm)	110.00	152.40	6030.0	MSM-222C-152-S4-ALPHY-H110 Mounts - Levelling - Studded - Hygienic - Anchoring - Low Profile High Swivel
7/8-9 UNC (22.23 mm)	110.00	152.40	6030.0	MSM-222C-152-S4-ALPHY-L110 Mounts - Levelling - Studded - Hygienic - Anchoring - Low Profile Low Swivel
7/8-9 UNC (22.23 mm)	110.00	203.20	6030.0	MSM-222C-203-S4-ALPHY-H110 Mounts - Levelling - Studded - Hygienic - Anchoring - Low Profile High Swivel
Thread Size (A) M24x3.00				
M24x3.00	80.00	150.00	500.0	MLM-240M-150-S4RP-I Mounts - Levelling - Studded - 303 Stainless - Industrial - Rubber Padded
M24x3.00	80.00	150.00	500.0	MLM-240M-150-CZRP Mounts - Levelling - Studded - Black Chromate - Swivel - Rubber Padded
M24x3.00	80.00	180.00	500.0	MLM-240M-180-S4RP-I Mounts - Levelling - Studded - 303 Stainless - Industrial - Rubber Padded
M24x3.00	80.00	180.00	500.0	MLM-240M-180-CZRP Mounts - Levelling - Studded - Black Chromate - Swivel - Rubber Padded
M24x3.00	80.00	200.00	500.0	MLM-240M-200-S4RP-I Mounts - Levelling - Studded - 303 Stainless - Industrial - Rubber Padded
M24x3.00	80.00	200.00	500.0	MLM-240M-200-CZRP Mounts - Levelling - Studded - Black Chromate - Swivel - Rubber Padded
M24x3.00	80.00	150.00	1000.0	MLM-240M-150-S4 Mounts - Levelling - Studded - 303 Stainless
M24x3.00	80.00	180.00	1000.0	MLM-240M-180-S4 Mounts - Levelling - Studded - 303 Stainless
M24x3.00	80.00	200.00	1000.0	MLM-240M-200-S4 Mounts - Levelling - Studded - 303 Stainless
M24x3.00	80.00	150.00	250.0	MLM-240M-150-S4NY-0LH Mounts - Levelling - Studded - Nylon - No Lag Holes
M24x3.00	80.00	150.00	250.0	MLM-240M-150-CNY-0LH Mounts - Levelling - Studded - Nylon - No Lag Holes
M24x3.00	80.00	180.00	250.0	MLM-240M-180-CNY-0LH Mounts - Levelling - Studded - Nylon - No Lag Holes
M24x3.00	80.00	180.00	250.0	MLM-240M-180-S4NY-0LH Mounts - Levelling - Studded - Nylon - No Lag Holes



 Usually stocked or Short Delivery
 ** Available while stocks last **

 Long Delivery or Large Minimum Quantities
 Not in current production

Studded Type



Thread Size (A)	Base Diameter (D) mm (in.)	Thread Length (F) mm (in.)	Load Rating Kg	Part Number
Thread Size (A) M24x3.00				
M24x3.00	80.00	200.00	250.0	MLM-240M-200-CNY-0LH Mounts - Levelling - Studded - Nylon - No Lag Holes
M24x3.00	80.00	200.00	250.0	MLM-240M-200-S4NY-0LH Mounts - Levelling - Studded - Nylon - No Lag Holes
M24x3.00	80.00	150.00	1000.0	MSM-240M-150-S4RP Mounts - Levelling - Studded - 303 Stainless - Swivel - Rubber Padded
M24x3.00	80.00	180.00	1000.0	MSM-240M-180-S4RP Mounts - Levelling - Studded - 303 Stainless - Swivel - Rubber Padded
M24x3.00	80.00	200.00	1000.0	MSM-240M-200-S4RP Mounts - Levelling - Studded - 303 Stainless - Swivel - Rubber Padded
M24x3.00	80.00	150.00	98.0	MLM-240M-150-ZPPH-ECO Mounts - Levelling - Studded - Economy - PVC Padded
M24x3.00	80.00	180.00	98.0	MLM-240M-180-ZPPH-ECO Mounts - Levelling - Studded - Economy - PVC Padded
M24x3.00	80.00	200.00	98.0	MLM-240M-200-ZPPH-ECO Mounts - Levelling - Studded - Economy - PVC Padded
M24x3.00	100.00	150.00	400.0	MLM-240M-150-NYCZRP Mounts - Levelling - Studded - Nylon - No Lag Holes
M24x3.00	100.00	180.00	400.0	MLM-240M-180-NYCZRP Mounts - Levelling - Studded - Nylon - No Lag Holes
M24x3.00	100.00	200.00	400.0	MLM-240M-200-NYCZRP Mounts - Levelling - Studded - Nylon - No Lag Holes
M24x3 (24 mm)	102.00	89.00	9000.0	MSM-240M-089-CNP Mounts - Levelling - Studded - Plated - Swivel
M24x3 (24 mm)	102.00	108.00	9000.0	MSM-240M-108-CNP Mounts - Levelling - Studded - Plated - Swivel
M24x3 (24 mm)	102.00	108.00	9980.0	MLM-240M-108-S3 Mounts - Levelling - Studded - 303 Stainless
M24x3 (24 mm)	102.00	108.00	9980.0	MLM-240M-108-CGC Mounts - Levelling - Studded - Gold Chromate
M24x3 (24 mm)	102.00	108.00	9980.0	MLM-240M-108-CNP Mounts - Levelling - Studded - Plated
M24x3 (24 mm)	102.00	89.00	6800.0	MSM-240M-089-CNPRP Mounts - Levelling - Studded - Plated - Swivel - Rubber Padded
M24x3 (24 mm)	102.00	108.00	6800.0	MSM-240M-108-CNPRP Mounts - Levelling - Studded - Plated - Swivel - Rubber Padded
Thread Size (A) 1-8 UNC (25.4 mm)				
1-8 UNC (25.4 mm)	101.60	108.00	9980.0	MLM-254C-108-S3 Mounts - Levelling - Studded - 303 Stainless
1-8 UNC (25.4 mm)	101.60	108.00	9980.0	MSM-254C-108-S3 Mounts - Levelling - Studded - 303 Stainless - Swivel
1-8 UNC (25.4 mm)	101.60	108.00	9980.0	MSM-254C-108-CBC Mounts - Levelling - Studded - Black Chromate - Swivel
1-8 UNC (25.4 mm)	101.60	108.00	9980.0	MSM-254C-108-CCC Mounts - Levelling - Studded - Clear Chromate - Swivel
1-8 UNC (25.4 mm)	101.60	108.00	9980.0	MLM-254C-108-CGC Mounts - Levelling - Studded - Gold Chromate
1-12 UNF (25.4 mm)	101.60	108.00	9980.0	MSM-254F-108-CGC Mounts - Levelling - Studded - Gold Chromate - Swivel
1-8 UNC (25.4 mm)	101.60	108.00	9980.0	MSM-254C-108-CGC Mounts - Levelling - Studded - Gold Chromate - Swivel
1-8 UNC (25.4 mm)	101.60	108.00	9980.0	MLM-254C-108-CNP Mounts - Levelling - Studded - Plated
1-8 UNC (25.4 mm)	101.60	203.20	9070.0	MSM-254C-203-CNP Mounts - Levelling - Studded - Plated - Swivel
1-8 UNC (25.4 mm)	101.60	203.20	9980.0	MLM-254C-203-S3 Mounts - Levelling - Studded - 303 Stainless



 Usually stocked or Short Delivery
 ** Available while stocks last **

 Long Delivery or Large Minimum Quantities
 Not in current production

Studded Type

Thread Size (A)	Base Diameter (D) mm (in.)	Thread Length (F) mm (in.)	Load Rating Kg	Part Number
Thread Size (A) 1-8 UNC (25.4 mm)				
1-8 UNC (25.4 mm)	101.60	203.20	9980.0	MSM-254C-203-S3 Mounts - Levelling - Studded - 303 Stainless - Swivel
1-8 UNC (25.4 mm)	101.60	203.20	9980.0	MSM-254C-203-CBC Mounts - Levelling - Studded - Black Chromate - Swivel
1-8 UNC (25.4 mm)	101.60	203.20	9980.0	MSM-254C-203-CCC Mounts - Levelling - Studded - Clear Chromate - Swivel
1-8 UNC (25.4 mm)	101.60	203.20	9980.0	MLM-254C-203-CGC Mounts - Levelling - Studded - Gold Chromate
1-8 UNC (25.4 mm)	101.60	203.20	9980.0	MSM-254C-203-CGC Mounts - Levelling - Studded - Gold Chromate - Swivel
1-8 UNC (25.4 mm)	101.60	203.20	9980.0	MLM-254C-203-CNP Mounts - Levelling - Studded - Plated
1-8 UNC (25.4 mm)	101.60	108.00	7440.0	MSM-254C-108-S3RP Mounts - Levelling - Studded - 303 Stainless - Swivel - Rubber Padded
1-8 UNC (25.4 mm)	101.60	108.00	7440.0	MSM-254C-108-CBCRP Mounts - Levelling - Studded - Black Chromate - Swivel - Rubber Padded
1-8 UNC (25.4 mm)	101.60	108.00	7440.0	MSM-254C-108-CGCRP Mounts - Levelling - Studded - Gold Chromate - Swivel - Rubber Padded
1-8 UNC (25.4 mm)	101.60	203.20	1090.0	MSM-254C-203-CGCAB Mounts - Levelling - Studded - Gold Chromate - Swivel - Acetal Base
1-8 UNC (25.4 mm)	101.60	203.20	7440.0	MSM-254C-203-S3RP Mounts - Levelling - Studded - 303 Stainless - Swivel - Rubber Padded
1-8 UNC (25.4 mm)	101.60	203.20	7440.0	MSM-254C-203-CGCRP Mounts - Levelling - Studded - Gold Chromate - Swivel - Rubber Padded
1-8 UNC (25.4 mm)	101.60	203.20	7660.0	MSM-254C-203-CCCRP Mounts - Levelling - Studded - Clear Chromate - Swivel - Rubber Padded
1-8 UNC (25.4 mm)	122.90	180.30	4490.0	MLM-254C-180-S3NY-LA2LH Mounts - Levelling - Studded - Nylon - Loc-A-Lign - With Lag Holes
1-8 UNC (25.4 mm)	122.90	125.20	4490.0	MLM-254C-125-S3NY-2LH Mounts - Levelling - Studded - Nylon - With Lag Holes
1-8 UNC (25.4 mm)	122.90	129.00	4490.0	MLM-254C-129-S3NY-2LH Mounts - Levelling - Studded - Nylon - With Lag Holes
1-8 UNC (25.4 mm)	122.90	150.60	3629.0	MLM-254C-151-CNY-0LH Mounts - Levelling - Studded - Nylon - No Lag Holes
Thread Size (A) 1.1/4-7 UNC (31.75 mm)				
1.1/4-7 UNC (31.75 mm)	122.90	125.20	4490.0	MLM-320C-125-S3NY-2LH Mounts - Levelling - Studded - Nylon - With Lag Holes

 Usually stocked or Short Delivery
 ** Available while stocks last **

 Long Delivery or Large Minimum Quantities
 Not in current production

NOTES

- Use the brief category description shown below each part number for a summary of the type, but more details will be shown online by typing the part number into the search box on any web page.
- The diagram online will be applicable to the part number selected. The diagrams at the front of this catalogue are for basic reference only.



Distributed By

Miniature Bearings Australia
<http://www.minibearings.com.au>
sales@minibearings.com.au

Resellers: Please place your contact sticker over our details

Avoid verbal communication

We sell an extensive range of products with varying amounts of technical data. Please assist us to provide you with accurate information by placing your orders and enquiries online or by e-mail.

Leveling Mounts