

MBA

2023.1

Ball Lock Pins

and Receptacles (Page 53)



Also known as detent pins, ball lock pins serve a similar purpose to clevis pins with the added benefit of quick release and insertion.

They come in carbon steel and stainless steel with a variety of head styles.

The simplest type just require pulling to release, whilst locking types require a button to be depressed in order to release.

Type the part number from this catalogue into the search box on any web page for delivery, stock levels and pricing.

Prefixes and Suffixes

BLP - 048 - 0127 - K1 - C

1 2 3 4 5

1. Product Identifier:

BLP: Ball Lock Pin

2. Pin Diameter Code:

Pin diameter in mm to 3 digits and 1 decimal place with decimal point removed.
ie, 048 = 4.76mm, 095 = 9.525mm, 100 = 10mm

3. Grip Length Code:

Grip length (to top of ball) in mm to 4 digits and 1 decimal place with the decimal point removed.
ie, 0127 = 12.7mm, 1016 = 101.6mm or 4 inches

4. Style:

BL: Ball Handle	RH: Ring Handle Industrial
BT: Button Handle	SHK: Shackle Style
DL: Double Acting L Style Handle	RSH: Ring Style Shouldered
DR: Double Acting Ring Handle	TSH: Tee Handle Shouldered
DT: Double Acting Tee Handle	TC: Tee Handle Commercial
HTI: High Tension Industrial	TI: Tee Handle Industrial
K1: Keyring Style - 1 Ball Plain Shank	THD: Tee Handle Heavy Duty
K2: Keyring Style - 2 Balls and Shoulder	THR: Threaded End (Add your own knob)
LI: L Style Industrial Handle	Blank: Basic Clevis Pin Style
MHR: Marine Stle Half Ring	
MRE: Marine Stle Recessed Head	

5. Material:

C: Carbon Steel
S17: Stainless Steel 17-4 PH
S3: Stainless Steel 303
S4: Stainless Steel 304
S6: Stainless Steel 316

These are just some of the most commonly used suffixes. Please refer to MBA for information on suffixes not listed.

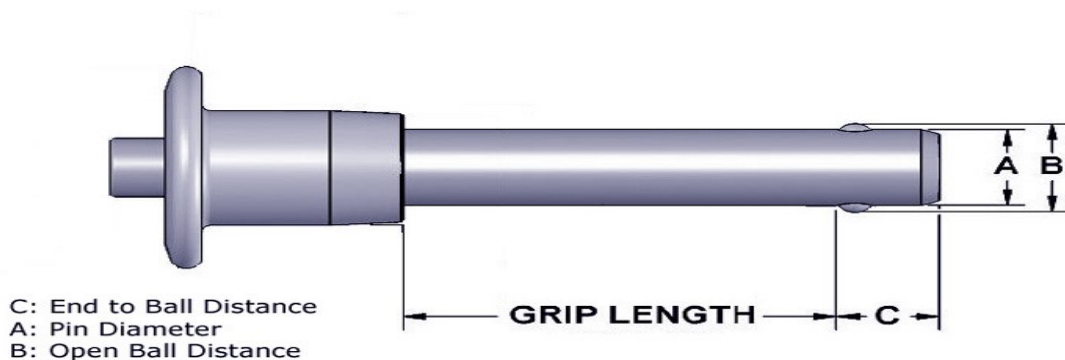

Example Diagram





Only the most common diagrams are shown. Other types are also listed in this catalogue.

Ball Lock Pins



Nominal Pin Dia. A (mm)	Grip Length (mm)	End Distance C (mm)	Open Ball Distance B (mm)	
4.76 x 6.35 mm (0.19 x 0.25 in.)				
4.76	6.35	5.08	5.18	304 Stainless Steel: Keyring Style - 300 Grade Stainless Steel - Dual Ball Part Number: BLP-048-0064-K2-S4
4.76	6.35	5.08	5.18	316 Stainless Steel: Keyring Style - 316 Stainless Steel Part Number: BLP-048-0064-K1-S6
4.76	6.35	6.60	5.59	304 Stainless Steel: Marine Style - Recessed Head Part Number: BLP-048-0064-MRE-S4
4.76 x 12.70 mm (0.19 x 0.50 in.)				
4.76	12.70			303 Stainless Steel: Threaded End - Stainless Steel Part Number: BLP-048-0127-THR-S3
4.76	12.70	5.08	5.18	303 Stainless Steel: Keyring Style - 300 Grade Stainless Steel - Single Ball Part Number: BLP-048-0127-K1-S3
4.76	12.70	5.08	5.18	304 Stainless Steel: Keyring Style - 300 Grade Stainless Steel - Dual Ball Part Number: BLP-048-0127-K2-S4
4.76	12.70	5.08	5.18	316 Stainless Steel: Keyring Style - 316 Stainless Steel Part Number: BLP-048-0127-K1-S6
4.76	12.70	5.08	5.18	Carbon Steel: Keyring Style - Steel Part Number: BLP-048-0127-K1-C
4.76	12.70	5.08	5.18	Carbon Steel: Shoulder Type - Ring Handle Part Number: BLP-048-0127-RSH-C
4.76	12.70	5.08	5.18	Carbon Steel: Shoulder Type - T Handle Part Number: BLP-048-0127-TSH-C
4.76	12.70	6.60	5.58	17-4 PH Stainless: T-Handle - Industrial - Stainless Steel Part Number: BLP-048-0127-TI-S17
4.76	12.70	6.60	5.58	17-4 PH Stainless / Aluminium Handle: Button Handle - Stainless Steel Part Number: BLP-048-0127-BT-S17
4.76	12.70	6.60	5.58	304 Stainless Steel: Marine Style - Half Ring Part Number: BLP-048-0127-MHR-S4
4.76	12.70	6.60	5.58	Alloy Steel / Aluminium Handle: T-Handle - Industrial - Steel and Aluminium Part Number: BLP-048-0127-TI-AC
4.76	12.70	6.60	5.58	Carbon Steel: Button Handle - Steel Part Number: BLP-048-0127-BT-C
4.76	12.70	6.60	5.58	Carbon Steel: Ring Handle - Industrial - Steel Part Number: BLP-048-0127-RHI-C
4.76	12.70	6.60	5.59	17-4 PH Stainless: Double Acting - Ring Handle - Stainless Steel Part Number: BLP-048-0127-DR-S17
4.76	12.70	6.60	5.59	17-4 PH Stainless: Double Acting - T-Handle - Stainless Steel Part Number: BLP-048-0127-DT-S17
4.76	12.70	6.60	5.59	304 Stainless Steel: Marine Style - Recessed Head Part Number: BLP-048-0127-MRE-S4
4.76 x 19.05 mm (0.19 x 0.75 in.)				
4.76	19.05	5.08	5.18	304 Stainless Steel: Keyring Style - 300 Grade Stainless Steel - Dual Ball Part Number: BLP-048-0191-K2-S4
4.76	19.05	5.08	5.18	316 Stainless Steel: Keyring Style - 316 Stainless Steel Part Number: BLP-048-0191-K1-S6
4.76	19.05	6.60	5.58	17-4 PH Stainless / Aluminium Handle: Button Handle - Stainless Steel Part Number: BLP-048-0191-BT-S17
4.76	19.05	6.60	5.58	304 Stainless Steel: Marine Style - Half Ring Part Number: BLP-048-0191-MHR-S4
4.76	19.05	6.60	5.59	304 Stainless Steel: Marine Style - Recessed Head Part Number: BLP-048-0191-MRE-S4
4.76 x 20.32 mm (0.19 x 0.80 in.)				
4.76	20.32	5.08	5.18	303 Stainless Steel: Keyring Style - 300 Grade Stainless Steel - Single Ball Part Number: BLP-048-0203-K1-S3
4.76	20.32	5.08	5.18	Carbon Steel: Keyring Style - Steel Part Number: BLP-048-0203-K1-C
4.76 x 25.40 mm (0.19 x 1.00 in.)				
4.76	25.40			303 Stainless Steel: Threaded End - Stainless Steel Part Number: BLP-048-0254-THR-S3
4.76	25.40	5.08	5.18	303 Stainless Steel: Keyring Style - 300 Grade Stainless Steel - Single Ball Part Number: BLP-048-0254-K1-S3



 Usually stocked or Short Delivery
 ** Available while stocks last **

 Long Delivery or Large Minimum Quantities
 Not in current production

Ball Lock Pins



Nominal Pin Dia. A (mm)	Grip Length (mm)	End Distance C (mm)	Open Ball Distance B (mm)	
4.76 x 25.40 mm (0.19 x 1.00 in.)				
4.76	25.40	5.08	5.18	304 Stainless Steel: Keyring Style - 300 Grade Stainless Steel - Dual Ball Part Number: ** BLP-048-0254-K2-S4
4.76	25.40	5.08	5.18	316 Stainless Steel: Keyring Style - 316 Stainless Steel Part Number: BLP-048-0254-K1-S6
4.76	25.40	5.08	5.18	Carbon Steel: Keyring Style - Steel Part Number: BLP-048-0254-K1-C
4.76	25.40	5.08	5.18	Carbon Steel: Shoulder Type - Ring Handle Part Number: BLP-048-0254-RSH-C
4.76	25.40	5.08	5.18	Carbon Steel: Shoulder Type - T Handle Part Number: BLP-048-0254-TSH-C
4.76	25.40	6.60	5.58	17-4 PH Stainless: Ring Handle - Industrial - Stainless Steel Part Number: BLP-048-0254-RHI-S17
4.76	25.40	6.60	5.58	17-4 PH Stainless: T-Handle - Industrial - Stainless Steel Part Number: BLP-048-0254-TI-S17
4.76	25.40	6.60	5.58	17-4 PH Stainless / Aluminium Handle: Button Handle - Stainless Steel Part Number: BLP-048-0254-BT-S17
4.76	25.40	6.60	5.58	304 Stainless Steel: Marine Style - Half Ring Part Number: BLP-048-0254-MHR-S4
4.76	25.40	6.60	5.58	Alloy Steel / Aluminium Handle: T-Handle - Industrial - Steel and Aluminium Part Number: BLP-048-0254-TI-AC
4.76	25.40	6.60	5.58	Carbon Steel: Button Handle - Steel Part Number: BLP-048-0254-BT-C
4.76	25.40	6.60	5.58	Carbon steel with aluminium handle, stainless ball and ring.: L-Handle - Industrial - Steel Part Number: BLP-048-0254-LI-C
4.76	25.40	6.60	5.59	17-4 PH Stainless: Double Acting - Ring Handle - Stainless Steel Part Number: BLP-048-0254-DR-S17
4.76	25.40	6.60	5.59	17-4 PH Stainless: Double Acting - T-Handle - Stainless Steel Part Number: BLP-048-0254-DT-S17
4.76	25.40	6.60	5.59	17-4 PH Stainless: L-Handle - Industrial - Stainless Steel Part Number: BLP-048-0254-LI-S17
4.76	25.40	6.60	5.59	304 Stainless Steel: Marine Style - Recessed Head Part Number: BLP-048-0254-MRE-S4
4.76 x 31.75 mm (0.19 x 1.25 in.)				
4.76	31.75	5.08	5.18	304 Stainless Steel: Keyring Style - 300 Grade Stainless Steel - Dual Ball Part Number: BLP-048-0318-K2-S4
4.76	31.75	5.08	5.18	316 Stainless Steel: Keyring Style - 316 Stainless Steel Part Number: BLP-048-0318-K1-S6
4.76	31.75	6.60	5.58	17-4 PH Stainless: Ring Handle - Industrial - Stainless Steel Part Number: BLP-048-0318-RHI-S17
4.76	31.75	6.60	5.58	17-4 PH Stainless / Aluminium Handle: Button Handle - Stainless Steel Part Number: BLP-048-0318-BT-S17
4.76	31.75	6.60	5.58	304 Stainless Steel: Marine Style - Half Ring Part Number: BLP-048-0318-MHR-S4
4.76	31.75	6.60	5.58	Carbon Steel: Button Handle - Steel Part Number: BLP-048-0318-BT-C
4.76	31.75	6.60	5.58	Carbon Steel: Ring Handle - Industrial - Steel Part Number: BLP-048-0318-RHI-C
4.76	31.75	6.60	5.59	304 Stainless Steel: Marine Style - Recessed Head Part Number: BLP-048-0318-MRE-S4
4.76 x 33.02 mm (0.19 x 1.30 in.)				
4.76	33.02	5.08	5.18	303 Stainless Steel: Keyring Style - 300 Grade Stainless Steel - Single Ball Part Number: BLP-048-0330-K1-S3
4.76	33.02	5.08	5.18	Carbon Steel: Keyring Style - Steel Part Number: BLP-048-0330-K1-C
4.76 x 38.10 mm (0.19 x 1.50 in.)				
4.76	38.10			303 Stainless Steel: Threaded End - Stainless Steel Part Number: BLP-048-0381-THR-S3
4.76	38.10	5.08	5.18	303 Stainless Steel: Keyring Style - 300 Grade Stainless Steel - Single Ball Part Number: BLP-048-0381-K1-S3



 Usually stocked or Short Delivery
 ** Available while stocks last **

 Long Delivery or Large Minimum Quantities
 Not in current production

Ball Lock Pins

Nominal Pin Dia. A (mm)	Grip Length (mm)	End Distance C (mm)	Open Ball Distance B (mm)	
4.76 x 38.10 mm (0.19 x 1.50 in.)				
4.76	38.10	5.08	5.18	304 Stainless Steel: Keyring Style - 300 Grade Stainless Steel - Dual Ball Part Number: BLP-048-0381-K2-S4
4.76	38.10	5.08	5.18	316 Stainless Steel: Keyring Style - 316 Stainless Steel Part Number: BLP-048-0381-K1-S6
4.76	38.10	5.08	5.18	Carbon Steel: Keyring Style - Steel Part Number: BLP-048-0381-K1-C
4.76	38.10	5.08	5.18	Carbon Steel: Shoulder Type - Ring Handle Part Number: BLP-048-0381-RSH-C
4.76	38.10	5.08	5.18	Carbon Steel: Shoulder Type - T Handle Part Number: BLP-048-0381-TSH-C
4.76	38.10	6.60	5.58	17-4 PH Stainless: T-Handle - Industrial - Stainless Steel Part Number: BLP-048-0381-TI-S17
4.76	38.10	6.60	5.58	17-4 PH Stainless / Aluminium Handle: Button Handle - Stainless Steel Part Number: BLP-048-0381-BT-S17
4.76	38.10	6.60	5.58	304 Stainless Steel: Marine Style - Half Ring Part Number: BLP-048-0381-MHR-S4
4.76	38.10	6.60	5.58	Alloy Steel / Aluminium Handle: T-Handle - Industrial - Steel and Aluminium Part Number: BLP-048-0381-TI-AC
4.76	38.10	6.60	5.58	Carbon steel with aluminium handle, stainless ball and ring.: L-Handle - Industrial - Steel Part Number: BLP-048-0381-LI-C
4.76	38.10	6.60	5.59	17-4 PH Stainless: Double Acting - T-Handle - Stainless Steel Part Number: BLP-048-0381-DT-S17
4.76	38.10	6.60	5.59	17-4 PH Stainless: L-Handle - Industrial - Stainless Steel Part Number: BLP-048-0381-LI-S17
4.76	38.10	6.60	5.59	304 Stainless Steel: Marine Style - Recessed Head Part Number: BLP-048-0381-MRE-S4
4.76 x 44.45 mm (0.19 x 1.75 in.)				
4.76	44.45	5.08	5.18	304 Stainless Steel: Keyring Style - 300 Grade Stainless Steel - Single Ball Part Number: BLP-048-0445-K1-S4
4.76	44.45	5.08	5.18	316 Stainless Steel: Keyring Style - 316 Stainless Steel Part Number: BLP-048-0445-K1-S6
4.76	44.45	6.60	5.58	304 Stainless Steel: Marine Style - Half Ring Part Number: BLP-048-0445-MHR-S4
4.76	44.45	6.60	5.59	304 Stainless Steel: Marine Style - Recessed Head Part Number: BLP-048-0445-MRE-S4
4.76 x 50.80 mm (0.19 x 2.00 in.)				
4.76	50.80	5.08	5.18	303 Stainless Steel: Keyring Style - 300 Grade Stainless Steel - Single Ball Part Number: BLP-048-0508-K1-S3
4.76	50.80	5.08	5.18	304 Stainless Steel: Keyring Style - 300 Grade Stainless Steel - Dual Ball Part Number: BLP-048-0508-K2-S4
4.76	50.80	5.08	5.18	316 Stainless Steel: Keyring Style - 316 Stainless Steel Part Number: BLP-048-0508-K1-S6
4.76	50.80	5.08	5.18	Carbon Steel: Keyring Style - Steel Part Number: BLP-048-0508-K1-C
4.76	50.80	5.08	5.18	Carbon Steel: Shoulder Type - Ring Handle Part Number: BLP-048-0508-RSH-C
4.76	50.80	5.08	5.18	Carbon Steel: Shoulder Type - T Handle Part Number: BLP-048-0508-TSH-C
4.76	50.80	6.60	5.58	17-4 PH Stainless: Ring Handle - Industrial - Stainless Steel Part Number: BLP-048-0508-RHI-S17
4.76	50.80	6.60	5.58	17-4 PH Stainless: T-Handle - Industrial - Stainless Steel Part Number: BLP-048-0508-TI-S17
4.76	50.80	6.60	5.58	17-4 PH Stainless / Aluminium Handle: Button Handle - Stainless Steel Part Number: BLP-048-0508-BT-S17
4.76	50.80	6.60	5.58	304 Stainless Steel: Marine Style - Half Ring Part Number: BLP-048-0508-MHR-S4
4.76	50.80	6.60	5.58	Alloy Steel / Aluminium Handle: T-Handle - Industrial - Steel and Aluminium Part Number: BLP-048-0508-TI-AC
4.76	50.80	6.60	5.58	Carbon Steel: Button Handle - Steel Part Number: BLP-048-0508-BT-C

 Usually stocked or Short Delivery
 ** Available while stocks last **

 Long Delivery or Large Minimum Quantities
 Not in current production

Ball Lock Pins



Nominal Pin Dia. A (mm)	Grip Length (mm)	End Distance C (mm)	Open Ball Distance B (mm)	
4.76 x 50.80 mm (0.19 x 2.00 in.)				
4.76	50.80	6.60	5.58	Carbon Steel: Ring Handle - Industrial - Steel Part Number: BLP-048-0508-RHI-C
4.76	50.80	6.60	5.58	Carbon steel with aluminium handle, stainless ball and ring.: L-Handle - Industrial - Steel Part Number: BLP-048-0508-LI-C
4.76	50.80	6.60	5.59	17-4 PH Stainless: Double Acting - Ring Handle - Stainless Steel Part Number: BLP-048-0508-DR-S17
4.76	50.80	6.60	5.59	17-4 PH Stainless: Double Acting - T-Handle - Stainless Steel Part Number: BLP-048-0508-DT-S17
4.76	50.80	6.60	5.59	304 Stainless Steel: Marine Style - Recessed Head Part Number: BLP-048-0508-MRE-S4
4.76 x 57.15 mm (0.19 x 2.25 in.)				
4.76	57.15	5.08	5.18	304 Stainless Steel: Keyring Style - 300 Grade Stainless Steel - Dual Ball Part Number: BLP-048-0572-K2-S4
4.76	57.15	5.08	5.18	316 Stainless Steel: Keyring Style - 316 Stainless Steel Part Number: BLP-048-0572-K1-S6
4.76	57.15	6.60	5.58	304 Stainless Steel: Marine Style - Half Ring Part Number: BLP-048-0572-MHR-S4
4.76	57.15	6.60	5.59	304 Stainless Steel: Marine Style - Recessed Head Part Number: BLP-048-0572-MRE-S4
4.76 x 63.50 mm (0.19 x 2.50 in.)				
4.76	63.50	5.08	5.18	303 Stainless Steel: Keyring Style - 300 Grade Stainless Steel - Single Ball Part Number: BLP-048-0635-K1-S3
4.76	63.50	5.08	5.18	304 Stainless Steel: Keyring Style - 300 Grade Stainless Steel - Dual Ball Part Number: BLP-048-0635-K2-S4
4.76	63.50	5.08	5.18	316 Stainless Steel: Keyring Style - 316 Stainless Steel Part Number: BLP-048-0635-K1-S6
4.76	63.50	5.08	5.18	Carbon Steel: Keyring Style - Steel Part Number: BLP-048-0635-K1-C
4.76	63.50	6.60	5.58	17-4 PH Stainless: T-Handle - Industrial - Stainless Steel Part Number: BLP-048-0635-TI-S17
4.76	63.50	6.60	5.58	17-4 PH Stainless / Aluminium Handle: Button Handle - Stainless Steel Part Number: BLP-048-0635-BT-S17
4.76	63.50	6.60	5.58	304 Stainless Steel: Marine Style - Half Ring Part Number: BLP-048-0635-MHR-S4
4.76	63.50	6.60	5.58	Alloy Steel / Aluminium Handle: T-Handle - Industrial - Steel and Aluminium Part Number: BLP-048-0635-TI-AC
4.76	63.50	6.60	5.58	Carbon Steel: Button Handle - Steel Part Number: BLP-048-0635-BT-C
4.76	63.50	6.60	5.58	Carbon steel with aluminium handle, stainless ball and ring.: L-Handle - Industrial - Steel Part Number: BLP-048-0635-LI-C
4.76	63.50	6.60	5.59	304 Stainless Steel: Marine Style - Recessed Head Part Number: BLP-048-0635-MRE-S4
4.76 x 69.85 mm (0.19 x 2.75 in.)				
4.76	69.85	5.08	5.18	304 Stainless Steel: Keyring Style - 300 Grade Stainless Steel - Dual Ball Part Number: BLP-048-0699-K2-S4
4.76	69.85	5.08	5.18	316 Stainless Steel: Keyring Style - 316 Stainless Steel Part Number: BLP-048-0699-K1-S6
4.76	69.85	6.60	5.58	304 Stainless Steel: Marine Style - Half Ring Part Number: BLP-048-0699-MHR-S4
4.76	69.85	6.60	5.59	304 Stainless Steel: Marine Style - Recessed Head Part Number: BLP-048-0699-MRE-S4
4.76 x 76.20 mm (0.19 x 3.00 in.)				
4.76	76.20	5.08	5.18	303 Stainless Steel: Keyring Style - 300 Grade Stainless Steel - Single Ball Part Number: BLP-048-0762-K1-S3
4.76	76.20	5.08	5.18	304 Stainless Steel: Keyring Style - 300 Grade Stainless Steel - Dual Ball Part Number: BLP-048-0762-K2-S4
4.76	76.20	5.08	5.18	316 Stainless Steel: Keyring Style - 316 Stainless Steel Part Number: BLP-048-0762-K1-S6
4.76	76.20	5.08	5.18	Carbon Steel: Keyring Style - Steel Part Number: BLP-048-0762-K1-C



Usually stocked or Short Delivery
** Available while stocks last **

Long Delivery or Large Minimum Quantities
Not in current production

Ball Lock Pins

Nominal Pin Dia. A (mm)	Grip Length (mm)	End Distance C (mm)	Open Ball Distance B (mm)	
4.76 x 76.20 mm (0.19 x 3.00 in.)				
4.76	76.20	6.60	5.58	17-4 PH Stainless: T-Handle - Industrial - Stainless Steel Part Number: BLP-048-0762-TI-S17
4.76	76.20	6.60	5.58	17-4 PH Stainless / Aluminium Handle: Button Handle - Stainless Steel Part Number: BLP-048-0762-BT-S17
4.76	76.20	6.60	5.58	304 Stainless Steel: Marine Style - Half Ring Part Number: BLP-048-0762-MHR-S4
4.76	76.20	6.60	5.58	Alloy Steel / Aluminium Handle: T-Handle - Industrial - Steel and Aluminium Part Number: BLP-048-0762-TI-AC
4.76	76.20	6.60	5.58	Carbon Steel: Button Handle - Steel Part Number: BLP-048-0762-BT-C
4.76	76.20	6.60	5.58	Carbon Steel: Ring Handle - Industrial - Steel Part Number: BLP-048-0762-RHI-C
4.76	76.20	6.60	5.59	17-4 PH Stainless: L-Handle - Industrial - Stainless Steel Part Number: BLP-048-0762-LI-S17
4.76	76.20	6.60	5.59	304 Stainless Steel: Marine Style - Recessed Head Part Number: BLP-048-0762-MRE-S4
4.76 x 101.60 mm (0.19 x 4.00 in.)				
4.76	101.60	6.60	5.58	Alloy Steel / Aluminium Handle: T-Handle - Industrial - Steel and Aluminium Part Number: BLP-048-1016-TI-AC
4.76	101.60	6.60	5.58	Carbon Steel: Button Handle - Steel Part Number: BLP-048-1016-BT-C
4.76	101.60	6.60	5.58	Carbon Steel: Ring Handle - Industrial - Steel Part Number: BLP-048-1016-RHI-C
4.76	101.60	6.60	5.58	Carbon steel with aluminium handle, stainless ball and ring.: L-Handle - Industrial - Steel Part Number: BLP-048-1016-LI-C
5.00 x 25.00 mm (0.20 x 0.98 in.)				
5.00	25.00	6.00	5.54	Alloy Steel / Aluminium Handle: T-Handle - Industrial - Steel and Aluminium Part Number: BLP-050-0250-TI-AC
6.00 x 15.00 mm (0.24 x 0.59 in.)				
6.00	15.00	7.00	6.99	17-4 PH Stainless / Aluminium Handle: T-Handle - Industrial - Stainless Steel and Aluminium Part Number: BLP-060-0150-TI-S17
6.00	15.00	7.00	6.99	Alloy Steel / Aluminium Handle: T-Handle - Industrial - Steel and Aluminium Part Number: BLP-060-0150-TI-AC
6.00 x 20.00 mm (0.24 x 0.79 in.)				
6.00	20.00	7.00	6.99	Alloy Steel / Aluminium Handle: T-Handle - Industrial - Steel and Aluminium Part Number: BLP-060-0200-TI-AC
6.00 x 25.00 mm (0.24 x 0.98 in.)				
6.00	25.00	7.00	6.99	17-4 PH Stainless / Aluminium Handle: T-Handle - Industrial - Stainless Steel and Aluminium Part Number: BLP-060-0250-TI-S17
6.00	25.00	7.00	6.99	Alloy Steel / Aluminium Handle: T-Handle - Industrial - Steel and Aluminium Part Number: BLP-060-0250-TI-AC
6.00 x 30.00 mm (0.24 x 1.18 in.)				
6.00	30.00	7.00	6.99	Alloy Steel / Aluminium Handle: T-Handle - Industrial - Steel and Aluminium Part Number: BLP-060-0300-TI-AC
6.00 x 40.00 mm (0.24 x 1.57 in.)				
6.00	40.00	7.00	6.99	17-4 PH Stainless / Aluminium Handle: T-Handle - Industrial - Stainless Steel and Aluminium Part Number: BLP-060-0400-TI-S17
6.00	40.00	7.00	6.99	Alloy Steel / Aluminium Handle: T-Handle - Industrial - Steel and Aluminium Part Number: BLP-060-0400-TI-AC
6.00 x 50.00 mm (0.24 x 1.97 in.)				
6.00	50.00	7.00	6.99	17-4 PH Stainless / Aluminium Handle: T-Handle - Industrial - Stainless Steel and Aluminium Part Number: BLP-060-0500-TI-S17
6.00	50.00	7.00	6.99	Alloy Steel / Aluminium Handle: T-Handle - Industrial - Steel and Aluminium Part Number: BLP-060-0500-TI-AC
6.00 x 65.00 mm (0.24 x 2.56 in.)				
6.00	65.00	7.00	6.99	17-4 PH Stainless / Aluminium Handle: T-Handle - Industrial - Stainless Steel and Aluminium Part Number: BLP-060-0650-TI-S17

 Usually stocked or Short Delivery
 ** Available while stocks last **

 Long Delivery or Large Minimum Quantities
 Not in current production

Ball Lock Pins

Nominal Pin Dia. A (mm)	Grip Length (mm)	End Distance C (mm)	Open Ball Distance B (mm)	
6.00 x 75.00 mm (0.24 x 2.95 in.)				
6.00	75.00	7.00	6.99	17-4 PH Stainless / Aluminium Handle: T-Handle - Industrial - Stainless Steel and Aluminium Part Number: BLP-060-0750-TI-S17
6.00 x 100.00 mm (0.24 x 3.94 in.)				
6.00	100.00	7.00	6.99	Alloy Steel / Aluminium Handle: T-Handle - Industrial - Steel and Aluminium Part Number: BLP-060-1000-TI-AC
6.35 x 6.35 mm (0.25 x 0.25 in.)				
6.35	6.35	7.93	7.26	304 Stainless Steel: Keyring Style - 300 Grade Stainless Steel - Dual Ball Part Number: BLP-064-0064-K2-S4
6.35	6.35	7.93	7.26	316 Stainless Steel: Keyring Style - 316 Stainless Steel Part Number: BLP-064-0064-K1-S6
6.35	6.35	9.65	7.29	304 Stainless Steel: Marine Style - Half Ring Part Number: BLP-064-0064-MHR-S4
6.35	6.35	9.65	7.89	304 Stainless Steel: Marine Style - Recessed Head Part Number: BLP-064-0064-MRE-S4
6.35 x 12.70 mm (0.25 x 0.50 in.)				
6.35	12.70			303 Stainless Steel: Threaded End - Stainless Steel Part Number: BLP-064-0127-THR-S3
6.35	12.70	7.36	7.34	17-4 PH Stainless: L-Handle - Industrial - Stainless Steel Part Number: BLP-064-0127-LI-S17
6.35	12.70	7.36	7.34	17-4 PH Stainless: Ring Handle - Industrial - Stainless Steel Part Number: BLP-064-0127-RHI-S17
6.35	12.70	7.36	7.34	17-4 PH Stainless: T-Handle - Industrial - Stainless Steel Part Number: BLP-064-0127-TI-S17
6.35	12.70	7.36	7.34	17-4 PH Stainless / Aluminium Handle: Button Handle - Stainless Steel Part Number: BLP-064-0127-BT-S17
6.35	12.70	7.36	7.34	Alloy Steel / Aluminium Handle: T-Handle - Industrial - Steel and Aluminium Part Number: BLP-064-0127-TI-AC
6.35	12.70	7.36	7.34	Carbon Steel: Button Handle - Steel Part Number: BLP-064-0127-BT-C
6.35	12.70	7.36	7.34	Carbon Steel: Ring Handle - Industrial - Steel Part Number: BLP-064-0127-RHI-C
6.35	12.70	7.36	7.34	Carbon steel with aluminium handle, stainless ball and ring.: L-Handle - Industrial - Steel Part Number: BLP-064-0127-LI-C
6.35	12.70	7.37	7.34	304 Stainless Steel: T-Handle - Commercial - 304 Stainless Steel Part Number: BLP-064-0127-T-S4
6.35	12.70	7.37	7.34	304 Stainless Steel Shank / Aluminium Handle: Button Handle - Commercial - 304 Stainless Part Number: BLP-064-0127-BT-S4
6.35	12.70	7.37	7.34	Carbon Steel: Button Handle - Commercial - Carbon Steel Part Number: BLP-064-0127-BTC-C
6.35	12.70	7.37	7.34	Carbon Steel: T-Handle - Commercial - Carbon Steel Part Number: BLP-064-0127-TC-C
6.35	12.70	7.93	7.26	303 Stainless Steel: Keyring Style - 300 Grade Stainless Steel - Single Ball Part Number: BLP-064-0127-K1-S3
6.35	12.70	7.93	7.26	304 Stainless Steel: Keyring Style - 300 Grade Stainless Steel - Dual Ball Part Number: BLP-064-0127-K2-S4
6.35	12.70	7.93	7.26	316 Stainless Steel: Keyring Style - 316 Stainless Steel Part Number: BLP-064-0127-K1-S6
6.35	12.70	7.93	7.26	Carbon Steel: Keyring Style - Steel Part Number: BLP-064-0127-K1-C
6.35	12.70	9.65	7.29	17-4 PH Stainless: T-Handle - Stainless Steel - Heavy Duty Part Number: BLP-064-0127-THD-S17
6.35	12.70	9.65	7.29	304 Stainless Steel: Marine Style - Half Ring Part Number: BLP-064-0127-MHR-S4
6.35	12.70	9.65	7.89	304 Stainless Steel: Marine Style - Recessed Head Part Number: BLP-064-0127-MRE-S4
6.35 x 15.24 mm (0.25 x 0.60 in.)				
6.35	15.24	7.93	7.26	Carbon Steel: Shoulder Type - Ring Handle Part Number: BLP-064-0152-RSH-C
6.35	15.24	7.93	7.26	Carbon Steel: Shoulder Type - T Handle Part Number: BLP-064-0152-TSH-C

Usually stocked or Short Delivery
** Available while stocks last **

Long Delivery or Large Minimum Quantities
Not in current production

Ball Lock Pins

Nominal Pin Dia. A (mm)	Grip Length (mm)	End Distance C (mm)	Open Ball Distance B (mm)	
6.35 x 19.05 mm (0.25 x 0.75 in.)				
6.35	19.05	7.36	7.34	17-4 PH Stainless / Aluminium Handle: Button Handle - Stainless Steel Part Number: BLP-064-0191-BT-S17
6.35	19.05	7.93	7.26	304 Stainless Steel: Keyring Style - 300 Grade Stainless Steel - Single Ball Part Number: BLP-064-0191-K1-S4
6.35	19.05	7.93	7.26	316 Stainless Steel: Keyring Style - 316 Stainless Steel Part Number: BLP-064-0191-K1-S6
6.35	19.05	9.65	7.29	304 Stainless Steel: Marine Style - Half Ring Part Number: BLP-064-0191-MHR-S4
6.35	19.05	9.65	7.89	304 Stainless Steel: Marine Style - Recessed Head Part Number: BLP-064-0191-MRE-S4
6.35 x 20.32 mm (0.25 x 0.80 in.)				
6.35	20.32	7.93	7.26	303 Stainless Steel: Keyring Style - 300 Grade Stainless Steel - Single Ball Part Number: BLP-064-0203-K1-S3
6.35	20.32	7.93	7.26	Carbon Steel: Keyring Style - Steel Part Number: BLP-064-0203-K1-C
6.35 x 25.40 mm (0.25 x 1.00 in.)				
6.35	25.40			303 Stainless Steel: Threaded End - Stainless Steel Part Number: BLP-064-0254-THR-S3
6.35	25.40	7.36	7.34	17-4 PH Stainless: L-Handle - Industrial - Stainless Steel Part Number: BLP-064-0254-LI-S17
6.35	25.40	7.36	7.34	17-4 PH Stainless: Ring Handle - Industrial - Stainless Steel Part Number: BLP-064-0254-RHI-S17
6.35	25.40	7.36	7.34	17-4 PH Stainless: T-Handle - Industrial - Stainless Steel Part Number: BLP-064-0254-TI-S17
6.35	25.40	7.36	7.34	17-4 PH Stainless / Aluminium Handle: Button Handle - Stainless Steel Part Number: BLP-064-0254-BT-S17
6.35	25.40	7.36	7.34	Alloy Steel / Aluminium Handle: T-Handle - Industrial - Steel and Aluminium Part Number: BLP-064-0254-TI-AC
6.35	25.40	7.36	7.34	Carbon Steel: Button Handle - Steel Part Number: BLP-064-0254-BT-C
6.35	25.40	7.36	7.34	Carbon Steel: Ring Handle - Industrial - Steel Part Number: BLP-064-0254-RHI-C
6.35	25.40	7.36	7.34	Carbon steel with aluminium handle, stainless ball and ring.: L-Handle - Industrial - Steel Part Number: BLP-064-0254-LI-C
6.35	25.40	7.37	7.34	17-4 PH or PH15-7MO shank with CRES440C spindle: High Tension - Industrial Part Number: BLP-064-0254-HTI-S17
6.35	25.40	7.37	7.34	17-4 PH Stainless: Double Acting - L-Handle - Stainless Steel Part Number: BLP-064-0254-DL-S17
6.35	25.40	7.37	7.34	17-4 PH Stainless: Double Acting - T-Handle - Stainless Steel Part Number: BLP-064-0254-DT-S17
6.35	25.40	7.37	7.34	304 Stainless Steel: T-Handle - Commercial - 304 Stainless Steel Part Number: BLP-064-0254-T-S4
6.35	25.40	7.37	7.34	304 Stainless Steel Shank / Aluminium Handle: Button Handle - Commercial - 304 Stainless Part Number: BLP-064-0254-BT-S4
6.35	25.40	7.37	7.34	Carbon Steel: Button Handle - Commercial - Carbon Steel Part Number: BLP-064-0254-BTC-C
6.35	25.40	7.37	7.34	Carbon Steel: T-Handle - Commercial - Carbon Steel Part Number: BLP-064-0254-TC-C
6.35	25.40	7.93	7.26	303 Stainless Steel: Keyring Style - 300 Grade Stainless Steel - Single Ball Part Number: BLP-064-0254-K1-S3
6.35	25.40	7.93	7.26	304 Stainless Steel: Keyring Style - 300 Grade Stainless Steel - Dual Ball Part Number: BLP-064-0254-K2-S4
6.35	25.40	7.93	7.26	316 Stainless Steel: Keyring Style - 316 Stainless Steel Part Number: BLP-064-0254-K1-S6
6.35	25.40	7.93	7.26	Carbon Steel: Keyring Style - Steel Part Number: BLP-064-0254-K1-C
6.35	25.40	7.93	7.26	Carbon Steel: Shoulder Type - Ring Handle Part Number: BLP-064-0254-RSH-C
6.35	25.40	7.93	7.26	Carbon Steel: Shoulder Type - T Handle Part Number: BLP-064-0254-TSH-C

Usually stocked or Short Delivery
** Available while stocks last **

Long Delivery or Large Minimum Quantities
Not in current production

Ball Lock Pins



Nominal Pin Dia. A (mm)	Grip Length (mm)	End Distance C (mm)	Open Ball Distance B (mm)	
6.35 x 25.40 mm (0.25 x 1.00 in.)				
6.35	25.40	7.93	7.26	Carbon Steel: T-Handle - Plastic Handle Part Number: BLP-064-0254-T-PC
6.35	25.40	7.93	7.26	Zinc Plated Carbon Steel: Ball Handle - Plastic Handle Part Number: BLP-064-0254-BL-C
6.35	25.40	9.65	7.29	17-4 PH Stainless: T-Handle - Stainless Steel - Heavy Duty Part Number: BLP-064-0254-THD-S17
6.35	25.40	9.65	7.29	304 Stainless Steel: Marine Style - Half Ring Part Number: BLP-064-0254-MHR-S4
6.35	25.40	9.65	7.89	304 Stainless Steel: Marine Style - Recessed Head Part Number: BLP-064-0254-MRE-S4
6.35 x 31.75 mm (0.25 x 1.25 in.)				
6.35	31.75	7.36	7.34	17-4 PH Stainless / Aluminium Handle: Button Handle - Stainless Steel Part Number: BLP-064-0317-BT-S17
6.35	31.75	7.93	7.26	304 Stainless Steel: Keyring Style - 300 Grade Stainless Steel - Dual Ball Part Number: BLP-064-0318-K2-S4
6.35	31.75	7.93	7.26	316 Stainless Steel: Keyring Style - 316 Stainless Steel Part Number: BLP-064-0318-K1-S6
6.35	31.75	9.65	7.29	304 Stainless Steel: Marine Style - Half Ring Part Number: BLP-064-0318-MHR-S4
6.35	31.75	9.65	7.89	304 Stainless Steel: Marine Style - Recessed Head Part Number: BLP-064-0318-MRE-S4
6.35 x 33.02 mm (0.25 x 1.30 in.)				
6.35	33.02	7.93	7.26	303 Stainless Steel: Keyring Style - 300 Grade Stainless Steel - Single Ball Part Number: BLP-064-0330-K1-S3
6.35	33.02	7.93	7.26	Carbon Steel: Keyring Style - Steel Part Number: BLP-064-0330-K1-C
6.35	33.02	7.93	7.26	Carbon Steel: Shoulder Type - Ring Handle Part Number: BLP-064-0330-RSH-C
6.35	33.02	7.93	7.26	Carbon Steel: Shoulder Type - T Handle Part Number: BLP-064-0330-TSH-C
6.35 x 38.10 mm (0.25 x 1.50 in.)				
6.35	38.10	7.36	7.34	17-4 PH Stainless: L-Handle - Industrial - Stainless Steel Part Number: BLP-064-0381-LI-S17
6.35	38.10	7.36	7.34	17-4 PH Stainless: Ring Handle - Industrial - Stainless Steel Part Number: BLP-064-0381-RHI-S17
6.35	38.10	7.36	7.34	17-4 PH Stainless: T-Handle - Industrial - Stainless Steel Part Number: BLP-064-0381-TI-S17
6.35	38.10	7.36	7.34	17-4 PH Stainless / Aluminium Handle: Button Handle - Stainless Steel Part Number: BLP-064-0381-BT-S17
6.35	38.10	7.36	7.34	Alloy Steel / Aluminium Handle: T-Handle - Industrial - Steel and Aluminium Part Number: BLP-064-0381-TI-AC
6.35	38.10	7.36	7.34	Carbon Steel: Button Handle - Steel Part Number: BLP-064-0381-BT-C
6.35	38.10	7.36	7.34	Carbon Steel: Ring Handle - Industrial - Steel Part Number: BLP-064-0381-RHI-C
6.35	38.10	7.36	7.34	Carbon steel with aluminium handle, stainless ball and ring.: L-Handle - Industrial - Steel Part Number: BLP-064-0381-LI-C
6.35	38.10	7.37	7.34	17-4 PH Stainless: Double Acting - Ring Handle - Stainless Steel Part Number: BLP-064-0381-DR-S17
6.35	38.10	7.37	7.34	17-4 PH Stainless: Double Acting - T-Handle - Stainless Steel Part Number: BLP-064-0381-DT-S17
6.35	38.10	7.37	7.34	304 Stainless Steel: T-Handle - Commercial - 304 Stainless Steel Part Number: BLP-064-0381-T-S4
6.35	38.10	7.37	7.34	304 Stainless Steel Shank / Aluminium Handle: Button Handle - Commercial - 304 Stainless Part Number: BLP-064-0381-BT-S4
6.35	38.10	7.37	7.34	Carbon Steel: Button Handle - Commercial - Carbon Steel Part Number: BLP-064-0381-BTC-C
6.35	38.10	7.37	7.34	Carbon Steel: T-Handle - Commercial - Carbon Steel Part Number: BLP-064-0381-TC-C
6.35	38.10	7.93	7.26	303 Stainless Steel: Keyring Style - 300 Grade Stainless Steel - Single Ball Part Number: BLP-064-0381-K1-S3



Usually stocked or Short Delivery
** Available while stocks last **

Long Delivery or Large Minimum Quantities
Not in current production

Ball Lock Pins



Nominal Pin Dia. A (mm)	Grip Length (mm)	End Distance C (mm)	Open Ball Distance B (mm)	
6.35 x 38.10 mm (0.25 x 1.50 in.)				
6.35	38.10	7.93	7.26	304 Stainless Steel: Keyring Style - 300 Grade Stainless Steel - Dual Ball Part Number: BLP-064-0381-K2-S4
6.35	38.10	7.93	7.26	316 Stainless Steel: Keyring Style - 316 Stainless Steel Part Number: BLP-064-0381-K1-S6
6.35	38.10	7.93	7.26	Carbon Steel: Keyring Style - Steel Part Number: BLP-064-0381-K1-C
6.35	38.10	7.93	7.26	Carbon Steel: Shoulder Type - Ring Handle Part Number: BLP-064-0381-RSH-C
6.35	38.10	7.93	7.26	Carbon Steel: Shoulder Type - T Handle Part Number: BLP-064-0381-TSH-C
6.35	38.10	7.93	7.26	Carbon Steel: T-Handle - Plastic Handle Part Number: BLP-064-0381-T-PC
6.35	38.10	7.93	7.26	Zinc Plated Carbon Steel: Ball Handle - Plastic Handle Part Number: BLP-064-0381-BL-C
6.35	38.10	9.65	7.29	17-4 PH Stainless: T-Handle - Stainless Steel - Heavy Duty Part Number: BLP-064-0381-THD-S17
6.35	38.10	9.65	7.29	304 Stainless Steel: Marine Style - Half Ring Part Number: BLP-064-0381-MHR-S4
6.35	38.10	9.65	7.89	304 Stainless Steel: Marine Style - Recessed Head Part Number: BLP-064-0381-MRE-S4
6.35 x 44.45 mm (0.25 x 1.75 in.)				
6.35	44.45	7.93	7.26	304 Stainless Steel: Keyring Style - 300 Grade Stainless Steel - Single Ball Part Number: BLP-064-0445-K1-S4
6.35	44.45	7.93	7.26	316 Stainless Steel: Keyring Style - 316 Stainless Steel Part Number: BLP-064-0445-K1-S6
6.35	44.45	9.65	7.29	304 Stainless Steel: Marine Style - Half Ring Part Number: BLP-064-0445-MHR-S4
6.35	44.45	9.65	7.89	304 Stainless Steel: Marine Style - Recessed Head Part Number: BLP-064-0445-MRE-S4
6.35 x 50.80 mm (0.25 x 2.00 in.)				
6.35	50.80			303 Stainless Steel: Threaded End - Stainless Steel Part Number: BLP-064-0508-THR-S3
6.35	50.80	7.36	7.34	17-4 PH Stainless: L-Handle - Industrial - Stainless Steel Part Number: BLP-064-0508-LI-S17
6.35	50.80	7.36	7.34	17-4 PH Stainless: Ring Handle - Industrial - Stainless Steel Part Number: BLP-064-0508-RHI-S17
6.35	50.80	7.36	7.34	17-4 PH Stainless: T-Handle - Industrial - Stainless Steel Part Number: BLP-064-0508-TI-S17
6.35	50.80	7.36	7.34	17-4 PH Stainless / Aluminium Handle: Button Handle - Stainless Steel Part Number: BLP-064-0508-BT-S17
6.35	50.80	7.36	7.34	Alloy Steel / Aluminium Handle: T-Handle - Industrial - Steel and Aluminium Part Number: BLP-064-0508-TI-AC
6.35	50.80	7.36	7.34	Carbon Steel: Button Handle - Steel Part Number: BLP-064-0508-BT-C
6.35	50.80	7.36	7.34	Carbon Steel: Ring Handle - Industrial - Steel Part Number: BLP-064-0508-RHI-C
6.35	50.80	7.36	7.34	Carbon steel with aluminium handle, stainless ball and ring.: L-Handle - Industrial - Steel Part Number: BLP-064-0508-LI-C
6.35	50.80	7.37	7.34	17-4 PH or PH15-7MO shank with CRES440C spindle: High Tension - Industrial Part Number: BLP-064-0508-HTI-S17
6.35	50.80	7.37	7.34	17-4 PH Stainless: Double Acting - Ring Handle - Stainless Steel Part Number: BLP-064-0508-DR-S17
6.35	50.80	7.37	7.34	17-4 PH Stainless: Double Acting - T-Handle - Stainless Steel Part Number: BLP-064-0508-DT-S17
6.35	50.80	7.37	7.34	304 Stainless Steel: T-Handle - Commercial - 304 Stainless Steel Part Number: BLP-064-0508-T-S4
6.35	50.80	7.37	7.34	304 Stainless Steel Shank / Aluminium Handle: Button Handle - Commercial - 304 Stainless Part Number: BLP-064-0508-BT-S4
6.35	50.80	7.37	7.34	Carbon Steel: Button Handle - Commercial - Carbon Steel Part Number: BLP-064-0508-BTC-C



 Usually stocked or Short Delivery
 ** Available while stocks last **

 Long Delivery or Large Minimum Quantities
 Not in current production

Ball Lock Pins



Nominal Pin Dia. A (mm)	Grip Length (mm)	End Distance C (mm)	Open Ball Distance B (mm)	
6.35 x 50.80 mm (0.25 x 2.00 in.)				
6.35	50.80	7.37	7.34	Carbon Steel: T-Handle - Commercial - Carbon Steel Part Number: BLP-064-0508-TC-C
6.35	50.80	7.93	7.26	303 Stainless Steel: Keyring Style - 300 Grade Stainless Steel - Single Ball Part Number: BLP-064-0508-K1-S3
6.35	50.80	7.93	7.26	304 Stainless Steel: Keyring Style - 300 Grade Stainless Steel - Dual Ball Part Number: BLP-064-0508-K2-S4
6.35	50.80	7.93	7.26	316 Stainless Steel: Keyring Style - 316 Stainless Steel Part Number: BLP-064-0508-K1-S6
6.35	50.80	7.93	7.26	Carbon Steel: Keyring Style - Steel Part Number: BLP-064-0508-K1-C
6.35	50.80	7.93	7.26	Carbon Steel: Shoulder Type - Ring Handle Part Number: BLP-064-0508-RSH-C
6.35	50.80	7.93	7.26	Carbon Steel: Shoulder Type - T Handle Part Number: BLP-064-0508-TSH-C
6.35	50.80	7.93	7.26	Carbon Steel: T-Handle - Plastic Handle Part Number: BLP-064-0508-T-PC
6.35	50.80	7.93	7.26	Zinc Plated Carbon Steel: Ball Handle - Plastic Handle Part Number: BLP-064-0508-BL-C
6.35	50.80	9.65	7.29	17-4 PH Stainless: T-Handle - Stainless Steel - Heavy Duty Part Number: BLP-064-0508-THD-S17
6.35	50.80	9.65	7.29	304 Stainless Steel: Marine Style - Half Ring Part Number: BLP-064-0508-MHR-S4
6.35	50.80	9.65	7.89	304 Stainless Steel: Marine Style - Recessed Head Part Number: BLP-064-0508-MRE-S4
6.35 x 57.15 mm (0.25 x 2.25 in.)				
6.35	57.15	7.93	7.26	304 Stainless Steel: Keyring Style - 300 Grade Stainless Steel - Single Ball Part Number: BLP-064-0572-K1-S4
6.35	57.15	7.93	7.26	316 Stainless Steel: Keyring Style - 316 Stainless Steel Part Number: BLP-064-0572-K1-S6
6.35	57.15	9.65	7.29	304 Stainless Steel: Marine Style - Half Ring Part Number: BLP-064-0572-MHR-S4
6.35	57.15	9.65	7.89	304 Stainless Steel: Marine Style - Recessed Head Part Number: BLP-064-0572-MRE-S4
6.35 x 63.50 mm (0.25 x 2.50 in.)				
6.35	63.50			303 Stainless Steel: Threaded End - Stainless Steel Part Number: BLP-064-0635-THR-S3
6.35	63.50	7.36	7.34	17-4 PH Stainless: L-Handle - Industrial - Stainless Steel Part Number: BLP-064-0635-LI-S17
6.35	63.50	7.36	7.34	17-4 PH Stainless: Ring Handle - Industrial - Stainless Steel Part Number: BLP-064-0635-RHI-S17
6.35	63.50	7.36	7.34	17-4 PH Stainless: T-Handle - Industrial - Stainless Steel Part Number: BLP-064-0635-TI-S17
6.35	63.50	7.36	7.34	17-4 PH Stainless / Aluminium Handle: Button Handle - Stainless Steel Part Number: BLP-064-0635-BT-S17
6.35	63.50	7.36	7.34	Alloy Steel / Aluminium Handle: T-Handle - Industrial - Steel and Aluminium Part Number: BLP-064-0635-TI-AC
6.35	63.50	7.36	7.34	Carbon Steel: Button Handle - Steel Part Number: BLP-064-0635-BT-C
6.35	63.50	7.36	7.34	Carbon Steel: Ring Handle - Industrial - Steel Part Number: BLP-064-0635-RHI-C
6.35	63.50	7.36	7.34	Carbon steel with aluminium handle, stainless ball and ring.: L-Handle - Industrial - Steel Part Number: BLP-064-0635-LI-C
6.35	63.50	7.37	7.34	17-4 PH or PH15-7MO shank with CRES440C spindle: High Tension - Industrial Part Number: BLP-064-0635-HTI-S17
6.35	63.50	7.37	7.34	17-4 PH Stainless: Double Acting - Ring Handle - Stainless Steel Part Number: BLP-064-0635-DR-S17
6.35	63.50	7.37	7.34	17-4 PH Stainless: Double Acting - T-Handle - Stainless Steel Part Number: BLP-064-0635-DT-S17
6.35	63.50	7.37	7.34	304 Stainless Steel: T-Handle - Commercial - 304 Stainless Steel Part Number: BLP-064-0635-T-S4



 Usually stocked or Short Delivery
 ** Available while stocks last **

 Long Delivery or Large Minimum Quantities
 Not in current production

Ball Lock Pins

Nominal Pin Dia. A (mm)	Grip Length (mm)	End Distance C (mm)	Open Ball Distance B (mm)	
6.35 x 63.50 mm		<i>(0.25 x 2.50 in.)</i>		
6.35	63.50	7.37	7.34	304 Stainless Steel Shank / Aluminium Handle: Button Handle - Commercial - 304 Stainless Part Number: BLP-064-0635-BT-S4
6.35	63.50	7.37	7.34	Carbon Steel: Button Handle - Commercial - Carbon Steel Part Number: BLP-064-0635-BTC-C
6.35	63.50	7.37	7.34	Carbon Steel: T-Handle - Commercial - Carbon Steel Part Number: BLP-064-0635-TC-C
6.35	63.50	7.93	7.26	303 Stainless Steel: Keyring Style - 300 Grade Stainless Steel - Single Ball Part Number: BLP-064-0635-K1-S3
6.35	63.50	7.93	7.26	304 Stainless Steel: Keyring Style - 300 Grade Stainless Steel - Single Ball Part Number: BLP-064-0635-K1-S4
6.35	63.50	7.93	7.26	316 Stainless Steel: Keyring Style - 316 Stainless Steel Part Number: BLP-064-0635-K1-S6
6.35	63.50	7.93	7.26	Carbon Steel: Keyring Style - Steel Part Number: BLP-064-0635-K1-C
6.35	63.50	7.93	7.26	Carbon Steel: T-Handle - Plastic Handle Part Number: BLP-064-0635-T-PC
6.35	63.50	7.93	7.26	Zinc Plated Carbon Steel: Ball Handle - Plastic Handle Part Number: BLP-064-0635-BL-C
6.35	63.50	9.65	7.29	17-4 PH Stainless: T-Handle - Stainless Steel - Heavy Duty Part Number: BLP-064-0635-THD-S17
6.35	63.50	9.65	7.29	304 Stainless Steel: Marine Style - Half Ring Part Number: BLP-064-0635-MHR-S4
6.35	63.50	9.65	7.89	304 Stainless Steel: Marine Style - Recessed Head Part Number: BLP-064-0635-MRE-S4
6.35 x 69.85 mm		<i>(0.25 x 2.75 in.)</i>		
6.35	69.85	7.93	7.26	304 Stainless Steel: Keyring Style - 300 Grade Stainless Steel - Dual Ball Part Number: BLP-064-0699-K2-S4
6.35	69.85	7.93	7.26	316 Stainless Steel: Keyring Style - 316 Stainless Steel Part Number: BLP-064-0699-K1-S6
6.35	69.85	9.65	7.29	304 Stainless Steel: Marine Style - Half Ring Part Number: BLP-064-0699-MHR-S4
6.35	69.85	9.65	7.89	304 Stainless Steel: Marine Style - Recessed Head Part Number: BLP-064-0699-MRE-S4
6.35 x 76.20 mm		<i>(0.25 x 3.00 in.)</i>		
6.35	76.20	7.36	7.34	17-4 PH Stainless: L-Handle - Industrial - Stainless Steel Part Number: BLP-064-0762-LI-S17
6.35	76.20	7.36	7.34	17-4 PH Stainless: Ring Handle - Industrial - Stainless Steel Part Number: BLP-064-0762-RHI-S17
6.35	76.20	7.36	7.34	17-4 PH Stainless: T-Handle - Industrial - Stainless Steel Part Number: BLP-064-0762-TI-S17
6.35	76.20	7.36	7.34	17-4 PH Stainless / Aluminium Handle: Button Handle - Stainless Steel Part Number: BLP-064-0762-BT-S17
6.35	76.20	7.36	7.34	Alloy Steel / Aluminium Handle: T-Handle - Industrial - Steel and Aluminium Part Number: BLP-064-0762-TI-AC
6.35	76.20	7.36	7.34	Carbon Steel: Button Handle - Steel Part Number: BLP-064-0762-BT-C
6.35	76.20	7.36	7.34	Carbon Steel: Ring Handle - Industrial - Steel Part Number: BLP-064-0762-RHI-C
6.35	76.20	7.36	7.34	Carbon steel with aluminium handle, stainless ball and ring.: L-Handle - Industrial - Steel Part Number: BLP-064-0762-LI-C
6.35	76.20	7.37	7.34	17-4 PH or PH15-7MO shank with CRES440C spindle: High Tension - Industrial Part Number: BLP-064-0762-HTI-S17
6.35	76.20	7.37	7.34	17-4 PH Stainless: Double Acting - T-Handle - Stainless Steel Part Number: BLP-064-0762-DT-S17
6.35	76.20	7.37	7.34	304 Stainless Steel: T-Handle - Commercial - 304 Stainless Steel Part Number: BLP-064-0762-T-S4
6.35	76.20	7.37	7.34	304 Stainless Steel Shank / Aluminium Handle: Button Handle - Commercial - 304 Stainless Part Number: BLP-064-0762-BT-S4
6.35	76.20	7.37	7.34	Carbon Steel: Button Handle - Commercial - Carbon Steel Part Number: BLP-064-0762-BTC-C

 Usually stocked or Short Delivery
 ** Available while stocks last **

 Long Delivery or Large Minimum Quantities
 Not in current production

Ball Lock Pins

Nominal Pin Dia. A (mm)	Grip Length (mm)	End Distance C (mm)	Open Ball Distance B (mm)	
6.35 x 76.20 mm (0.25 x 3.00 in.)				
6.35	76.20	7.37	7.34	Carbon Steel: T-Handle - Commercial - Carbon Steel Part Number: BLP-064-0762-TC-C
6.35	76.20	7.93	7.26	303 Stainless Steel: Keyring Style - 300 Grade Stainless Steel - Single Ball Part Number: BLP-064-0762-K1-S3
6.35	76.20	7.93	7.26	304 Stainless Steel: Keyring Style - 300 Grade Stainless Steel - Dual Ball Part Number: BLP-064-0762-K2-S4
6.35	76.20	7.93	7.26	316 Stainless Steel: Keyring Style - 316 Stainless Steel Part Number: BLP-064-0762-K1-S6
6.35	76.20	7.93	7.26	Carbon Steel: Keyring Style - Steel Part Number: BLP-064-0762-K1-C
6.35	76.20	7.93	7.26	Carbon Steel: Shoulder Type - Ring Handle Part Number: BLP-064-0762-RSH-C
6.35	76.20	7.93	7.26	Carbon Steel: Shoulder Type - T Handle Part Number: BLP-064-0762-TSH-C
6.35	76.20	7.93	7.26	Carbon Steel: T-Handle - Plastic Handle Part Number: BLP-064-0762-T-PC
6.35	76.20	7.93	7.26	Zinc Plated Carbon Steel: Ball Handle - Plastic Handle Part Number: BLP-064-0762-BL-C
6.35	76.20	9.65	7.29	17-4 PH Stainless: T-Handle - Stainless Steel - Heavy Duty Part Number: BLP-064-0762-THD-S17
6.35	76.20	9.65	7.29	304 Stainless Steel: Marine Style - Half Ring Part Number: BLP-064-0762-MHR-S4
6.35	76.20	9.65	7.89	304 Stainless Steel: Marine Style - Recessed Head Part Number: BLP-064-0762-MRE-S4
6.35 x 82.55 mm (0.25 x 3.25 in.)				
6.35	82.55	7.93	7.26	304 Stainless Steel: Keyring Style - 300 Grade Stainless Steel - Dual Ball Part Number: BLP-064-0826-K2-S4
6.35	82.55	7.93	7.26	316 Stainless Steel: Keyring Style - 316 Stainless Steel Part Number: BLP-064-0826-K1-S6
6.35	82.55	9.65	7.29	304 Stainless Steel: Marine Style - Half Ring Part Number: BLP-064-0826-MHR-S4
6.35	82.55	9.65	7.89	304 Stainless Steel: Marine Style - Recessed Head Part Number: BLP-064-0826-MRE-S4
6.35 x 88.90 mm (0.25 x 3.50 in.)				
6.35	88.90	7.36	7.34	17-4 PH Stainless: T-Handle - Industrial - Stainless Steel Part Number: BLP-064-0889-TI-S17
6.35	88.90	7.36	7.34	17-4 PH Stainless / Aluminium Handle: Button Handle - Stainless Steel Part Number: BLP-064-0889-BT-S17
6.35	88.90	7.36	7.34	Alloy Steel / Aluminium Handle: T-Handle - Industrial - Steel and Aluminium Part Number: BLP-064-0889-TI-AC
6.35	88.90	7.36	7.34	Carbon Steel: Button Handle - Steel Part Number: BLP-064-0889-BT-C
6.35	88.90	7.36	7.34	Carbon Steel: Ring Handle - Industrial - Steel Part Number: BLP-064-0889-RHI-C
6.35	88.90	7.36	7.34	Carbon steel with aluminium handle, stainless ball and ring.: L-Handle - Industrial - Steel Part Number: BLP-064-0889-LI-C
6.35	88.90	7.37	7.34	304 Stainless Steel: T-Handle - Commercial - 304 Stainless Steel Part Number: BLP-064-0889-T-S4
6.35	88.90	7.37	7.34	304 Stainless Steel Shank / Aluminium Handle: Button Handle - Commercial - 304 Stainless Part Number: BLP-064-0889-BT-S4
6.35	88.90	7.37	7.34	Carbon Steel: Button Handle - Commercial - Carbon Steel Part Number: BLP-064-0889-BTC-C
6.35	88.90	7.37	7.34	Carbon Steel: T-Handle - Commercial - Carbon Steel Part Number: BLP-064-0889-TC-C
6.35	88.90	7.93	7.26	304 Stainless Steel: Keyring Style - 300 Grade Stainless Steel - Dual Ball Part Number: BLP-064-0889-K2-S4
6.35	88.90	7.93	7.26	316 Stainless Steel: Keyring Style - 316 Stainless Steel Part Number: BLP-064-0889-K1-S6
6.35	88.90	9.65	7.29	304 Stainless Steel: Marine Style - Half Ring Part Number: BLP-064-0889-MHR-S4
6.35	88.90	9.65	7.89	304 Stainless Steel: Marine Style - Recessed Head Part Number: BLP-064-0889-MRE-S4

Usually stocked or Short Delivery
** Available while stocks last **

Long Delivery or Large Minimum Quantities
Not in current production

Ball Lock Pins

Nominal Pin Dia. A (mm)	Grip Length (mm)	End Distance C (mm)	Open Ball Distance B (mm)	
6.35 x 95.25 mm (0.25 x 3.75 in.)				
6.35	95.25	7.93	7.26	304 Stainless Steel: Keyring Style - 300 Grade Stainless Steel - Dual Ball Part Number: BLP-064-0953-K2-S4
6.35	95.25	7.93	7.26	316 Stainless Steel: Keyring Style - 316 Stainless Steel Part Number: BLP-064-0953-K1-S6
6.35	95.25	9.65	7.29	304 Stainless Steel: Marine Style - Half Ring Part Number: BLP-064-0953-MHR-S4
6.35	95.25	9.65	7.89	304 Stainless Steel: Marine Style - Recessed Head Part Number: BLP-064-0953-MRE-S4
6.35 x 101.60 mm (0.25 x 4.00 in.)				
6.35	101.60	7.36	7.34	17-4 PH Stainless: T-Handle - Industrial - Stainless Steel Part Number: BLP-064-1016-TI-S17
6.35	101.60	7.36	7.34	Alloy Steel / Aluminium Handle: T-Handle - Industrial - Steel and Aluminium Part Number: BLP-064-1016-TI-AC
6.35	101.60	7.36	7.34	Carbon steel with aluminium handle, stainless ball and ring.: L-Handle - Industrial - Steel Part Number: BLP-064-1016-LI-C
6.35	101.60	7.37	7.34	17-4 PH or PH15-7MO shank with CRES440C spindle: High Tension - Industrial Part Number: BLP-064-1016-HTI-S17
6.35	101.60	7.37	7.34	304 Stainless Steel: T-Handle - Commercial - 304 Stainless Steel Part Number: BLP-064-1016-T-S4
6.35	101.60	7.37	7.34	304 Stainless Steel Shank / Aluminium Handle: Button Handle - Commercial - 304 Stainless Part Number: BLP-064-1016-BT-S4
6.35	101.60	7.37	7.34	Carbon Steel: Button Handle - Commercial - Carbon Steel Part Number: BLP-064-1016-BTC-C
6.35	101.60	7.37	7.34	Carbon Steel: T-Handle - Commercial - Carbon Steel Part Number: BLP-064-1016-TC-C
6.35	101.60	7.93	7.26	304 Stainless Steel: Keyring Style - 300 Grade Stainless Steel - Single Ball Part Number: BLP-064-1016-K1-S4
6.35	101.60	7.93	7.26	316 Stainless Steel: Keyring Style - 316 Stainless Steel Part Number: BLP-064-1016-K1-S6
6.35	101.60	8.38	9.52	17-4 PH Stainless / Aluminium Handle: Button Handle - Stainless Steel Part Number: BLP-064-1016-BT-S17
6.35	101.60	8.38	9.52	Carbon Steel: Button Handle - Steel Part Number: BLP-064-1016-BT-C
6.35	101.60	8.38	9.52	Carbon Steel: Ring Handle - Industrial - Steel Part Number: BLP-064-1016-RHI-C
6.35	101.60	9.65	7.29	17-4 PH Stainless: T-Handle - Stainless Steel - Heavy Duty Part Number: BLP-064-1016-THD-S17
6.35	101.60	9.65	7.29	304 Stainless Steel: Marine Style - Half Ring Part Number: BLP-064-1016-MHR-S4
6.35 x 114.30 mm (0.25 x 4.50 in.)				
6.35	114.30	7.36	7.34	Carbon steel with aluminium handle, stainless ball and ring.: L-Handle - Industrial - Steel Part Number: BLP-064-1143-LI-C
6.35	114.30	9.65	7.29	17-4 PH Stainless: T-Handle - Stainless Steel - Heavy Duty Part Number: BLP-064-1143-THD-S17
7.94 x 6.35 mm (0.31 x 0.25 in.)				
7.94	6.35	9.53	9.09	304 Stainless Steel: Keyring Style - 300 Grade Stainless Steel - Dual Ball Part Number: BLP-079-0064-K2-S4
7.94	6.35	9.53	9.09	316 Stainless Steel: Keyring Style - 316 Stainless Steel Part Number: BLP-079-0064-K1-S6
7.94	6.35	10.16	9.45	304 Stainless Steel: Marine Style - Half Ring Part Number: BLP-079-0064-MHR-S4
7.94	6.35	10.16	9.45	304 Stainless Steel: Marine Style - Recessed Head Part Number: BLP-079-0064-MRE-S4
7.94 x 12.70 mm (0.31 x 0.50 in.)				
7.94	12.70	8.38	9.52	Alloy Steel / Aluminium Handle: T-Handle - Industrial - Steel and Aluminium Part Number: BLP-079-0127-TI-AC
7.94	12.70	8.38	9.52	Carbon Steel: Button Handle - Steel Part Number: BLP-079-0127-BT-C
7.94	12.70	8.38	9.53	17-4 PH or PH15-7MO shank with CRES440C spindle: High Tension - Industrial Part Number: BLP-079-0127-HTI-S17

Usually stocked or Short Delivery
** Available while stocks last **

Long Delivery or Large Minimum Quantities
Not in current production

Ball Lock Pins

Nominal Pin Dia. A (mm)	Grip Length (mm)	End Distance C (mm)	Open Ball Distance B (mm)	
7.94 x 12.70 mm (0.31 x 0.50 in.)				
7.94	12.70	8.38	9.53	304 Stainless Steel: T-Handle - Commercial - 304 Stainless Steel Part Number: BLP-079-0127-T-S4
7.94	12.70	8.38	9.53	Carbon Steel: T-Handle - Commercial - Carbon Steel Part Number: BLP-079-0127-TC-C
7.94	12.70	9.53	9.09	304 Stainless Steel: Keyring Style - 300 Grade Stainless Steel - Dual Ball Part Number: BLP-079-0127-K2-S4
7.94	12.70	9.53	9.09	316 Stainless Steel: Keyring Style - 316 Stainless Steel Part Number: BLP-079-0127-K1-S6
7.94	12.70	10.16	9.45	17-4 PH Stainless: T-Handle - Stainless Steel - Heavy Duty Part Number: BLP-079-0127-THD-S17
7.94	12.70	10.16	9.45	304 Stainless Steel: Marine Style - Half Ring Part Number: BLP-079-0127-MHR-S4
7.94	12.70	10.16	9.45	304 Stainless Steel: Marine Style - Recessed Head Part Number: BLP-079-0127-MRE-S4
7.94 x 19.05 mm (0.31 x 0.75 in.)				
7.94	19.05	8.38	9.52	17-4 PH Stainless / Aluminium Handle: Button Handle - Stainless Steel Part Number: BLP-079-0191-BT-S17
7.94	19.05	9.53	9.09	304 Stainless Steel: Keyring Style - 300 Grade Stainless Steel - Dual Ball Part Number: BLP-079-0191-K2-S4
7.94	19.05	9.53	9.09	316 Stainless Steel: Keyring Style - 316 Stainless Steel Part Number: BLP-079-0191-K1-S6
7.94	19.05	10.16	9.45	304 Stainless Steel: Marine Style - Half Ring Part Number: BLP-079-0191-MHR-S4
7.94	19.05	10.16	9.45	304 Stainless Steel: Marine Style - Recessed Head Part Number: BLP-079-0191-MRE-S4
7.94 x 20.32 mm (0.31 x 0.80 in.)				
7.94	20.32	9.53	9.09	303 Stainless Steel: Keyring Style - 300 Grade Stainless Steel - Single Ball Part Number: BLP-079-0203-K1-S3
7.94	20.32	9.53	9.09	Carbon Steel: Keyring Style - Steel Part Number: BLP-079-0203-K1-C
7.94 x 25.40 mm (0.31 x 1.00 in.)				
7.94	25.40			303 Stainless Steel: Threaded End - Stainless Steel Part Number: BLP-079-0254-THR-S3
7.94	25.40	8.38	9.52	17-4 PH Stainless: Ring Handle - Industrial - Stainless Steel Part Number: BLP-079-0254-RHI-S17
7.94	25.40	8.38	9.52	17-4 PH Stainless: T-Handle - Industrial - Stainless Steel Part Number: BLP-079-0254-TI-S17
7.94	25.40	8.38	9.52	17-4 PH Stainless / Aluminium Handle: Button Handle - Stainless Steel Part Number: BLP-079-0254-BT-S17
7.94	25.40	8.38	9.52	Alloy Steel / Aluminium Handle: T-Handle - Industrial - Steel and Aluminium Part Number: BLP-079-0254-TI-AC
7.94	25.40	8.38	9.52	Carbon Steel: Button Handle - Steel Part Number: BLP-079-0254-BT-C
7.94	25.40	8.38	9.52	Carbon Steel: Ring Handle - Industrial - Steel Part Number: BLP-079-0254-RHI-C
7.94	25.40	8.38	9.52	Carbon steel with aluminium handle, stainless ball and ring.: L-Handle - Industrial - Steel Part Number: BLP-079-0254-LI-C
7.94	25.40	8.38	9.53	17-4 PH or PH15-7MO shank with CRES440C spindle: High Tension - Industrial Part Number: BLP-079-0254-HTI-S17
7.94	25.40	8.38	9.53	17-4 PH Stainless: Double Acting - Ring Handle - Stainless Steel Part Number: BLP-079-0254-DR-S17
7.94	25.40	8.38	9.53	17-4 PH Stainless: Double Acting - T-Handle - Stainless Steel Part Number: BLP-079-0254-DT-S17
7.94	25.40	8.38	9.53	17-4 PH Stainless: L-Handle - Industrial - Stainless Steel Part Number: BLP-079-0254-LI-S17
7.94	25.40	8.38	9.53	304 Stainless Steel: T-Handle - Commercial - 304 Stainless Steel Part Number: BLP-079-0254-T-S4
7.94	25.40	8.38	9.53	304 Stainless Steel Shank / Aluminium Handle: Button Handle - Commercial - 304 Stainless Part Number: BLP-079-0254-BT-S4
7.94	25.40	8.38	9.53	Carbon Steel: Button Handle - Commercial - Carbon Steel Part Number: BLP-079-0254-BTC-C

Usually stocked or Short Delivery
** Available while stocks last **

Long Delivery or Large Minimum Quantities
Not in current production

Ball Lock Pins



Nominal Pin Dia. A (mm)	Grip Length (mm)	End Distance C (mm)	Open Ball Distance B (mm)	
7.94 x 25.40 mm (0.31 x 1.00 in.)				
7.94	25.40	8.38	9.53	Carbon Steel: T-Handle - Commercial - Carbon Steel Part Number: BLP-079-0254-TC-C
7.94	25.40	9.53	9.09	303 Stainless Steel: Keyring Style - 300 Grade Stainless Steel - Single Ball Part Number: BLP-079-0254-K1-S3
7.94	25.40	9.53	9.09	304 Stainless Steel: Keyring Style - 300 Grade Stainless Steel - Dual Ball Part Number: BLP-079-0254-K2-S4
7.94	25.40	9.53	9.09	316 Stainless Steel: Keyring Style - 316 Stainless Steel Part Number: BLP-079-0254-K1-S6
7.94	25.40	9.53	9.09	Carbon Steel: Keyring Style - Steel Part Number: BLP-079-0254-K1-C
7.94	25.40	9.53	9.09	Carbon Steel: Shoulder Type - Ring Handle Part Number: BLP-079-0254-RSH-C
7.94	25.40	9.53	9.09	Carbon Steel: Shoulder Type - T Handle Part Number: BLP-079-0254-TSH-C
7.94	25.40	10.16	9.45	17-4 PH Stainless: T-Handle - Stainless Steel - Heavy Duty Part Number: BLP-079-0254-THD-S17
7.94	25.40	10.16	9.45	304 Stainless Steel: Marine Style - Half Ring Part Number: BLP-079-0254-MHR-S4
7.94	25.40	10.16	9.45	304 Stainless Steel: Marine Style - Recessed Head Part Number: BLP-079-0254-MRE-S4
7.94 x 31.75 mm (0.31 x 1.25 in.)				
7.94	31.75	8.38	9.52	17-4 PH Stainless / Aluminium Handle: Button Handle - Stainless Steel Part Number: BLP-079-0317-BT-S17
7.94	31.75	9.53	9.09	304 Stainless Steel: Keyring Style - 300 Grade Stainless Steel - Dual Ball Part Number: BLP-079-0318-K2-S4
7.94	31.75	9.53	9.09	316 Stainless Steel: Keyring Style - 316 Stainless Steel Part Number: BLP-079-0318-K1-S6
7.94	31.75	10.16	9.45	304 Stainless Steel: Marine Style - Half Ring Part Number: BLP-079-0318-MHR-S4
7.94	31.75	10.16	9.45	304 Stainless Steel: Marine Style - Recessed Head Part Number: BLP-079-0318-MRE-S4
7.94 x 33.02 mm (0.31 x 1.30 in.)				
7.94	33.02	9.53	9.09	303 Stainless Steel: Keyring Style - 300 Grade Stainless Steel - Single Ball Part Number: BLP-079-0330-K1-S3
7.94	33.02	9.53	9.09	Carbon Steel: Keyring Style - Steel Part Number: BLP-079-0330-K1-C
7.94 x 38.10 mm (0.31 x 1.50 in.)				
7.94	38.10			303 Stainless Steel: Threaded End - Stainless Steel Part Number: BLP-079-0381-THR-S3
7.94	38.10	8.38	9.52	17-4 PH Stainless: Ring Handle - Industrial - Stainless Steel Part Number: BLP-079-0381-RHI-S17
7.94	38.10	8.38	9.52	17-4 PH Stainless: T-Handle - Industrial - Stainless Steel Part Number: BLP-079-0381-TI-S17
7.94	38.10	8.38	9.52	17-4 PH Stainless / Aluminium Handle: Button Handle - Stainless Steel Part Number: BLP-079-0381-BT-S17
7.94	38.10	8.38	9.52	Alloy Steel / Aluminium Handle: T-Handle - Industrial - Steel and Aluminium Part Number: BLP-079-0381-TI-AC
7.94	38.10	8.38	9.52	Carbon Steel: Button Handle - Steel Part Number: BLP-079-0381-BT-C
7.94	38.10	8.38	9.52	Carbon Steel: Ring Handle - Industrial - Steel Part Number: BLP-079-0381-RHI-C
7.94	38.10	8.38	9.52	Carbon steel with aluminium handle, stainless ball and ring.: L-Handle - Industrial - Steel Part Number: BLP-079-0381-LI-C
7.94	38.10	8.38	9.53	17-4 PH or PH15-7MO shank with CRES440C spindle: High Tension - Industrial Part Number: BLP-079-0381-HTI-S17
7.94	38.10	8.38	9.53	17-4 PH Stainless: Double Acting - L-Handle - Stainless Steel Part Number: BLP-079-0381-DL-S17
7.94	38.10	8.38	9.53	17-4 PH Stainless: Double Acting - Ring Handle - Stainless Steel Part Number: BLP-079-0381-DR-S17
7.94	38.10	8.38	9.53	17-4 PH Stainless: Double Acting - T-Handle - Stainless Steel Part Number: BLP-079-0381-DT-S17



Usually stocked or Short Delivery
** Available while stocks last **

Long Delivery or Large Minimum Quantities
Not in current production

Ball Lock Pins

Nominal Pin Dia. A (mm)	Grip Length (mm)	End Distance C (mm)	Open Ball Distance B (mm)	
7.94 x 38.10 mm (0.31 x 1.50 in.)				
7.94	38.10	8.38	9.53	17-4 PH Stainless: L-Handle - Industrial - Stainless Steel Part Number: BLP-079-0381-LI-S17
7.94	38.10	8.38	9.53	304 Stainless Steel: T-Handle - Commercial - 304 Stainless Steel Part Number: BLP-079-0381-T-S4
7.94	38.10	8.38	9.53	304 Stainless Steel Shank / Aluminium Handle: Button Handle - Commercial - 304 Stainless Part Number: BLP-079-0381-BT-S4
7.94	38.10	8.38	9.53	Carbon Steel: Button Handle - Commercial - Carbon Steel Part Number: BLP-079-0381-BTC-C
7.94	38.10	8.38	9.53	Carbon Steel: T-Handle - Commercial - Carbon Steel Part Number: BLP-079-0381-TC-C
7.94	38.10	9.53	9.09	303 Stainless Steel: Keyring Style - 300 Grade Stainless Steel - Single Ball Part Number: BLP-079-0381-K1-S3
7.94	38.10	9.53	9.09	304 Stainless Steel: Keyring Style - 300 Grade Stainless Steel - Dual Ball Part Number: BLP-079-0381-K2-S4
7.94	38.10	9.53	9.09	316 Stainless Steel: Keyring Style - 316 Stainless Steel Part Number: BLP-079-0381-K1-S6
7.94	38.10	9.53	9.09	Carbon Steel: Keyring Style - Steel Part Number: BLP-079-0381-K1-C
7.94	38.10	9.53	9.09	Carbon Steel: Shoulder Type - Ring Handle Part Number: BLP-079-0381-RSH-C
7.94	38.10	9.53	9.09	Carbon Steel: Shoulder Type - T Handle Part Number: BLP-079-0381-TSH-C
7.94	38.10	9.53	9.09	Zinc Plated Carbon Steel: Ball Handle - Plastic Handle Part Number: BLP-079-0381-BL-C
7.94	38.10	10.16	9.45	17-4 PH Stainless: T-Handle - Stainless Steel - Heavy Duty Part Number: BLP-079-0381-THD-S17
7.94	38.10	10.16	9.45	304 Stainless Steel: Marine Style - Half Ring Part Number: BLP-079-0381-MHR-S4
7.94	38.10	10.16	9.45	304 Stainless Steel: Marine Style - Recessed Head Part Number: BLP-079-0381-MRE-S4
7.94 x 44.45 mm (0.31 x 1.75 in.)				
7.94	44.45	9.53	9.09	304 Stainless Steel: Keyring Style - 300 Grade Stainless Steel - Dual Ball Part Number: BLP-079-0445-K2-S4
7.94	44.45	9.53	9.09	316 Stainless Steel: Keyring Style - 316 Stainless Steel Part Number: BLP-079-0445-K1-S6
7.94	44.45	10.16	9.45	304 Stainless Steel: Marine Style - Half Ring Part Number: BLP-079-0445-MHR-S4
7.94 x 50.80 mm (0.31 x 2.00 in.)				
7.94	50.80	8.38	9.52	17-4 PH Stainless: Ring Handle - Industrial - Stainless Steel Part Number: BLP-079-0508-RHI-S17
7.94	50.80	8.38	9.52	17-4 PH Stainless: T-Handle - Industrial - Stainless Steel Part Number: BLP-079-0508-TI-S17
7.94	50.80	8.38	9.52	17-4 PH Stainless / Aluminium Handle: Button Handle - Stainless Steel Part Number: BLP-079-0508-BT-S17
7.94	50.80	8.38	9.52	Alloy Steel / Aluminium Handle: T-Handle - Industrial - Steel and Aluminium Part Number: BLP-079-0508-TI-AC
7.94	50.80	8.38	9.52	Carbon Steel: Button Handle - Steel Part Number: BLP-079-0508-BT-C
7.94	50.80	8.38	9.52	Carbon Steel: Ring Handle - Industrial - Steel Part Number: BLP-079-0508-RHI-C
7.94	50.80	8.38	9.52	Carbon steel with aluminium handle, stainless ball and ring.: L-Handle - Industrial - Steel Part Number: BLP-079-0508-LI-C
7.94	50.80	8.38	9.53	17-4 PH or PH15-7MO shank with CRES440C spindle: High Tension - Industrial Part Number: BLP-079-0508-HTI-S17
7.94	50.80	8.38	9.53	17-4 PH Stainless: Double Acting - T-Handle - Stainless Steel Part Number: BLP-079-0508-DT-S17
7.94	50.80	8.38	9.53	17-4 PH Stainless: L-Handle - Industrial - Stainless Steel Part Number: BLP-079-0508-LI-S17
7.94	50.80	8.38	9.53	304 Stainless Steel: T-Handle - Commercial - 304 Stainless Steel Part Number: BLP-079-0508-T-S4

 Usually stocked or Short Delivery
 ** Available while stocks last **

 Long Delivery or Large Minimum Quantities
 Not in current production

Ball Lock Pins



Nominal Pin Dia. A (mm)	Grip Length (mm)	End Distance C (mm)	Open Ball Distance B (mm)	
7.94 x 50.80 mm (0.31 x 2.00 in.)				
7.94	50.80	8.38	9.53	304 Stainless Steel Shank / Aluminium Handle: Button Handle - Commercial - 304 Stainless Part Number: BLP-079-0508-BT-S4
7.94	50.80	8.38	9.53	Carbon Steel: Button Handle - Commercial - Carbon Steel Part Number: BLP-079-0508-BTC-C
7.94	50.80	8.38	9.53	Carbon Steel: T-Handle - Commercial - Carbon Steel Part Number: BLP-079-0508-TC-C
7.94	50.80	9.53	9.09	303 Stainless Steel: Keyring Style - 300 Grade Stainless Steel - Single Ball Part Number: BLP-079-0508-K1-S3
7.94	50.80	9.53	9.09	304 Stainless Steel: Keyring Style - 300 Grade Stainless Steel - Dual Ball Part Number: BLP-079-0508-K2-S4
7.94	50.80	9.53	9.09	316 Stainless Steel: Keyring Style - 316 Stainless Steel Part Number: BLP-079-0508-K1-S6
7.94	50.80	9.53	9.09	Carbon Steel: Keyring Style - Steel Part Number: BLP-079-0508-K1-C
7.94	50.80	9.53	9.09	Carbon Steel: Shoulder Type - Ring Handle Part Number: BLP-079-0508-RSH-C
7.94	50.80	9.53	9.09	Carbon Steel: Shoulder Type - T Handle Part Number: BLP-079-0508-TSH-C
7.94	50.80	9.53	9.09	Carbon Steel: T-Handle - Plastic Handle Part Number: BLP-079-0508-T-PC
7.94	50.80	10.16	9.45	17-4 PH Stainless: T-Handle - Stainless Steel - Heavy Duty Part Number: BLP-079-0508-THD-S17
7.94	50.80	10.16	9.45	304 Stainless Steel: Marine Style - Half Ring Part Number: BLP-079-0508-MHR-S4
7.94	50.80	10.16	9.45	304 Stainless Steel: Marine Style - Recessed Head Part Number: BLP-079-0508-MRE-S4
7.94 x 57.15 mm (0.31 x 2.25 in.)				
7.94	57.15	9.53	9.09	304 Stainless Steel: Keyring Style - 300 Grade Stainless Steel - Dual Ball Part Number: BLP-079-0572-K2-S4
7.94	57.15	9.53	9.09	316 Stainless Steel: Keyring Style - 316 Stainless Steel Part Number: BLP-079-0572-K1-S6
7.94	57.15	10.16	9.45	304 Stainless Steel: Marine Style - Half Ring Part Number: BLP-079-0572-MHR-S4
7.94	57.15	10.16	9.45	304 Stainless Steel: Marine Style - Recessed Head Part Number: BLP-079-0572-MRE-S4
7.94 x 63.50 mm (0.31 x 2.50 in.)				
7.94	63.50	8.38	9.52	17-4 PH Stainless: Ring Handle - Industrial - Stainless Steel Part Number: BLP-079-0635-RHI-S17
7.94	63.50	8.38	9.52	17-4 PH Stainless: T-Handle - Industrial - Stainless Steel Part Number: BLP-079-0635-TI-S17
7.94	63.50	8.38	9.52	17-4 PH Stainless / Aluminium Handle: Button Handle - Stainless Steel Part Number: BLP-079-0635-BT-S17
7.94	63.50	8.38	9.52	Alloy Steel / Aluminium Handle: T-Handle - Industrial - Steel and Aluminium Part Number: BLP-079-0635-TI-AC
7.94	63.50	8.38	9.52	Carbon Steel: Button Handle - Steel Part Number: BLP-079-0635-BT-C
7.94	63.50	8.38	9.52	Carbon Steel: Ring Handle - Industrial - Steel Part Number: BLP-079-0635-RHI-C
7.94	63.50	8.38	9.52	Carbon steel with aluminium handle, stainless ball and ring.: L-Handle - Industrial - Steel Part Number: BLP-079-0635-LI-C
7.94	63.50	8.38	9.53	17-4 PH Stainless: Double Acting - Ring Handle - Stainless Steel Part Number: BLP-079-0635-DR-S17
7.94	63.50	8.38	9.53	17-4 PH Stainless: Double Acting - T-Handle - Stainless Steel Part Number: BLP-079-0635-DT-S17
7.94	63.50	8.38	9.53	17-4 PH Stainless: L-Handle - Industrial - Stainless Steel Part Number: BLP-079-0635-LI-S17
7.94	63.50	8.38	9.53	304 Stainless Steel: T-Handle - Commercial - 304 Stainless Steel Part Number: BLP-079-0635-T-S4
7.94	63.50	8.38	9.53	304 Stainless Steel Shank / Aluminium Handle: Button Handle - Commercial - 304 Stainless Part Number: BLP-079-0635-BT-S4



Usually stocked or Short Delivery
** Available while stocks last **

Long Delivery or Large Minimum Quantities
Not in current production

Ball Lock Pins



Nominal Pin Dia. A (mm)	Grip Length (mm)	End Distance C (mm)	Open Ball Distance B (mm)	
7.94 x 63.50 mm		<i>(0.31 x 2.50 in.)</i>		
7.94	63.50	8.38	9.53	Carbon Steel: Button Handle - Commercial - Carbon Steel Part Number: BLP-079-0635-BTC-C
7.94	63.50	8.38	9.53	Carbon Steel: T-Handle - Commercial - Carbon Steel Part Number: BLP-079-0635-TC-C
7.94	63.50	9.53	9.09	303 Stainless Steel: Keyring Style - 300 Grade Stainless Steel - Single Ball Part Number: BLP-079-0635-K1-S3
7.94	63.50	9.53	9.09	304 Stainless Steel: Keyring Style - 300 Grade Stainless Steel - Dual Ball Part Number: BLP-079-0635-K2-S4
7.94	63.50	9.53	9.09	316 Stainless Steel: Keyring Style - 316 Stainless Steel Part Number: BLP-079-0635-K1-S6
7.94	63.50	9.53	9.09	Carbon Steel: Keyring Style - Steel Part Number: BLP-079-0635-K1-C
7.94	63.50	9.53	9.09	Carbon Steel: T-Handle - Plastic Handle Part Number: BLP-079-0635-T-PC
7.94	63.50	10.16	9.45	17-4 PH Stainless: T-Handle - Stainless Steel - Heavy Duty Part Number: BLP-079-0635-THD-S17
7.94	63.50	10.16	9.45	304 Stainless Steel: Marine Style - Half Ring Part Number: BLP-079-0635-MHR-S4
7.94	63.50	10.16	9.45	304 Stainless Steel: Marine Style - Recessed Head Part Number: BLP-079-0635-MRE-S4
7.94 x 69.85 mm		<i>(0.31 x 2.75 in.)</i>		
7.94	69.85	9.53	9.09	304 Stainless Steel: Keyring Style - 300 Grade Stainless Steel - Dual Ball Part Number: BLP-079-0699-K2-S4
7.94	69.85	9.53	9.09	316 Stainless Steel: Keyring Style - 316 Stainless Steel Part Number: BLP-079-0699-K1-S6
7.94	69.85	10.16	9.45	304 Stainless Steel: Marine Style - Half Ring Part Number: BLP-079-0699-MHR-S4
7.94	69.85	10.16	9.45	304 Stainless Steel: Marine Style - Recessed Head Part Number: BLP-079-0699-MRE-S4
7.94 x 76.20 mm		<i>(0.31 x 3.00 in.)</i>		
7.94	76.20	8.38	9.52	17-4 PH Stainless: T-Handle - Industrial - Stainless Steel Part Number: BLP-079-0762-TI-S17
7.94	76.20	8.38	9.52	17-4 PH Stainless / Aluminium Handle: Button Handle - Stainless Steel Part Number: BLP-079-0762-BT-S17
7.94	76.20	8.38	9.52	Alloy Steel / Aluminium Handle: T-Handle - Industrial - Steel and Aluminium Part Number: BLP-079-0762-TI-AC
7.94	76.20	8.38	9.52	Carbon Steel: Button Handle - Steel Part Number: BLP-079-0762-BT-C
7.94	76.20	8.38	9.52	Carbon Steel: Ring Handle - Industrial - Steel Part Number: BLP-079-0762-RHI-C
7.94	76.20	8.38	9.52	Carbon steel with aluminium handle, stainless ball and ring.: L-Handle - Industrial - Steel Part Number: BLP-079-0762-LI-C
7.94	76.20	8.38	9.53	17-4 PH or PH15-7MO shank with CRES440C spindle: High Tension - Industrial Part Number: BLP-079-0762-HTI-S17
7.94	76.20	8.38	9.53	17-4 PH Stainless: L-Handle - Industrial - Stainless Steel Part Number: BLP-079-0762-LI-S17
7.94	76.20	8.38	9.53	304 Stainless Steel: T-Handle - Commercial - 304 Stainless Steel Part Number: BLP-079-0762-T-S4
7.94	76.20	8.38	9.53	304 Stainless Steel Shank / Aluminium Handle: Button Handle - Commercial - 304 Stainless Part Number: BLP-079-0762-BT-S4
7.94	76.20	8.38	9.53	Carbon Steel: Button Handle - Commercial - Carbon Steel Part Number: BLP-079-0762-BTC-C
7.94	76.20	8.38	9.53	Carbon Steel: T-Handle - Commercial - Carbon Steel Part Number: BLP-079-0762-TC-C
7.94	76.20	9.27	11.18	17-4 PH Stainless: Double Acting - T-Handle - Stainless Steel Part Number: BLP-079-0762-DT-S17
7.94	76.20	9.53	9.09	303 Stainless Steel: Keyring Style - 300 Grade Stainless Steel - Single Ball Part Number: BLP-079-0762-K1-S3
7.94	76.20	9.53	9.09	304 Stainless Steel: Keyring Style - 300 Grade Stainless Steel - Dual Ball Part Number: BLP-079-0762-K2-S4



 Usually stocked or Short Delivery
 ** Available while stocks last **

 Long Delivery or Large Minimum Quantities
 Not in current production

Ball Lock Pins

Nominal Pin Dia. A (mm)	Grip Length (mm)	End Distance C (mm)	Open Ball Distance B (mm)	
7.94 x 76.20 mm (0.31 x 3.00 in.)				
7.94	76.20	9.53	9.09	316 Stainless Steel: Keyring Style - 316 Stainless Steel Part Number: BLP-079-0762-K1-S6
7.94	76.20	9.53	9.09	Carbon Steel: Keyring Style - Steel Part Number: BLP-079-0762-K1-C
7.94	76.20	10.16	9.45	17-4 PH Stainless: T-Handle - Stainless Steel - Heavy Duty Part Number: BLP-079-0762-THD-S17
7.94	76.20	10.16	9.45	304 Stainless Steel: Marine Style - Half Ring Part Number: BLP-079-0762-MHR-S4
7.94	76.20	10.16	9.45	304 Stainless Steel: Marine Style - Recessed Head Part Number: BLP-079-0762-MRE-S4
7.94 x 82.55 mm (0.31 x 3.25 in.)				
7.94	82.55	9.53	9.09	304 Stainless Steel: Keyring Style - 300 Grade Stainless Steel - Dual Ball Part Number: BLP-079-0826-K2-S4
7.94	82.55	9.53	9.09	316 Stainless Steel: Keyring Style - 316 Stainless Steel Part Number: BLP-079-0826-K1-S6
7.94	82.55	10.16	9.45	304 Stainless Steel: Marine Style - Half Ring Part Number: BLP-079-0826-MHR-S4
7.94	82.55	10.16	9.45	304 Stainless Steel: Marine Style - Recessed Head Part Number: BLP-079-0826-MRE-S4
7.94 x 88.90 mm (0.31 x 3.50 in.)				
7.94	88.90	8.38	9.52	17-4 PH Stainless: T-Handle - Industrial - Stainless Steel Part Number: BLP-079-0889-TI-S17
7.94	88.90	8.38	9.52	17-4 PH Stainless / Aluminium Handle: Button Handle - Stainless Steel Part Number: BLP-079-0889-BT-S17
7.94	88.90	8.38	9.52	Alloy Steel / Aluminium Handle: T-Handle - Industrial - Steel and Aluminium Part Number: BLP-079-0889-TI-AC
7.94	88.90	8.38	9.52	Carbon Steel: Button Handle - Steel Part Number: BLP-079-0889-BT-C
7.94	88.90	8.38	9.53	304 Stainless Steel: T-Handle - Commercial - 304 Stainless Steel Part Number: BLP-079-0889-T-S4
7.94	88.90	8.38	9.53	304 Stainless Steel Shank / Aluminium Handle: Button Handle - Commercial - 304 Stainless Part Number: BLP-079-0889-BT-S4
7.94	88.90	8.38	9.53	Carbon Steel: Button Handle - Commercial - Carbon Steel Part Number: BLP-079-0889-BTC-C
7.94	88.90	8.38	9.53	Carbon Steel: T-Handle - Commercial - Carbon Steel Part Number: BLP-079-0889-TC-C
7.94	88.90	9.53	9.09	303 Stainless Steel: Keyring Style - 300 Grade Stainless Steel - Single Ball Part Number: BLP-079-0889-K1-S3
7.94	88.90	9.53	9.09	304 Stainless Steel: Keyring Style - 300 Grade Stainless Steel - Dual Ball Part Number: BLP-079-0889-K2-S4
7.94	88.90	9.53	9.09	316 Stainless Steel: Keyring Style - 316 Stainless Steel Part Number: BLP-079-0889-K1-S6
7.94	88.90	9.53	9.09	Carbon Steel: Keyring Style - Steel Part Number: BLP-079-0889-K1-C
7.94	88.90	10.16	9.45	17-4 PH Stainless: T-Handle - Stainless Steel - Heavy Duty Part Number: BLP-079-0889-THD-S17
7.94	88.90	10.16	9.45	304 Stainless Steel: Marine Style - Half Ring Part Number: BLP-079-0889-MHR-S4
7.94	88.90	10.16	9.45	304 Stainless Steel: Marine Style - Recessed Head Part Number: BLP-079-0889-MRE-S4
7.94 x 95.25 mm (0.31 x 3.75 in.)				
7.94	95.25	9.53	9.09	304 Stainless Steel: Keyring Style - 300 Grade Stainless Steel - Dual Ball Part Number: BLP-079-0953-K2-S4
7.94	95.25	9.53	9.09	316 Stainless Steel: Keyring Style - 316 Stainless Steel Part Number: BLP-079-0953-K1-S6
7.94	95.25	10.16	9.45	304 Stainless Steel: Marine Style - Half Ring Part Number: BLP-079-0953-MHR-S4
7.94	95.25	10.16	9.45	304 Stainless Steel: Marine Style - Recessed Head Part Number: BLP-079-0953-MRE-S4

 Usually stocked or Short Delivery
 ** Available while stocks last **

 Long Delivery or Large Minimum Quantities
 Not in current production

Ball Lock Pins



Nominal Pin Dia. A (mm)	Grip Length (mm)	End Distance C (mm)	Open Ball Distance B (mm)	
7.94 x 101.60 mm (0.31 x 4.00 in.)				
7.94	101.60	8.38	9.52	17-4 PH Stainless: T-Handle - Industrial - Stainless Steel Part Number: BLP-079-1016-TI-S17
7.94	101.60	8.38	9.52	17-4 PH Stainless / Aluminium Handle: Button Handle - Stainless Steel Part Number: BLP-079-1016-BT-S17
7.94	101.60	8.38	9.52	Alloy Steel / Aluminium Handle: T-Handle - Industrial - Steel and Aluminium Part Number: BLP-079-1016-TI-AC
7.94	101.60	8.38	9.52	Carbon Steel: Button Handle - Steel Part Number: BLP-079-1016-BT-C
7.94	101.60	8.38	9.52	Carbon Steel: Ring Handle - Industrial - Steel Part Number: BLP-079-1016-RHI-C
7.94	101.60	8.38	9.52	Carbon steel with aluminium handle, stainless ball and ring.: L-Handle - Industrial - Steel Part Number: BLP-079-1016-LI-C
7.94	101.60	8.38	9.53	17-4 PH or PH15-7MO shank with CRES440C spindle: High Tension - Industrial Part Number: BLP-079-1016-HTI-S17
7.94	101.60	8.38	9.53	17-4 PH Stainless: L-Handle - Industrial - Stainless Steel Part Number: BLP-079-1016-LI-S17
7.94	101.60	8.38	9.53	304 Stainless Steel: T-Handle - Commercial - 304 Stainless Steel Part Number: BLP-079-1016-T-S4
7.94	101.60	8.38	9.53	304 Stainless Steel Shank / Aluminium Handle: Button Handle - Commercial - 304 Stainless Part Number: BLP-079-1016-BT-S4
7.94	101.60	8.38	9.53	Carbon Steel: Button Handle - Commercial - Carbon Steel Part Number: BLP-079-1016-BTC-C
7.94	101.60	8.38	9.53	Carbon Steel: T-Handle - Commercial - Carbon Steel Part Number: BLP-079-1016-TC-C
7.94	101.60	9.53	9.09	303 Stainless Steel: Keyring Style - 300 Grade Stainless Steel - Single Ball Part Number: BLP-079-1016-K1-S3
7.94	101.60	9.53	9.09	304 Stainless Steel: Keyring Style - 300 Grade Stainless Steel - Dual Ball Part Number: BLP-079-1016-K2-S4
7.94	101.60	9.53	9.09	316 Stainless Steel: Keyring Style - 316 Stainless Steel Part Number: BLP-079-1016-K1-S6
7.94	101.60	9.53	9.09	Carbon Steel: Keyring Style - Steel Part Number: BLP-079-1016-K1-C
7.94	101.60	10.16	9.45	17-4 PH Stainless: T-Handle - Stainless Steel - Heavy Duty Part Number: BLP-079-1016-THD-S17
7.94	101.60	10.16	9.45	304 Stainless Steel: Marine Style - Half Ring Part Number: BLP-079-1016-MHR-S4
7.94	101.60	10.16	9.45	304 Stainless Steel: Marine Style - Recessed Head Part Number: BLP-079-1016-MRE-S4
7.94 x 114.30 mm (0.31 x 4.50 in.)				
7.94	114.30	8.38	9.52	Alloy Steel / Aluminium Handle: T-Handle - Industrial - Steel and Aluminium Part Number: BLP-079-1143-TI-AC
7.94	114.30	8.38	9.52	Carbon Steel: Button Handle - Steel Part Number: BLP-079-1143-BT-C
7.94	114.30	8.38	9.52	Carbon Steel: Ring Handle - Industrial - Steel Part Number: BLP-079-1143-RHI-C
7.94	114.30	10.16	9.45	17-4 PH Stainless: T-Handle - Stainless Steel - Heavy Duty Part Number: BLP-079-1143-THD-S17
7.94 x 127.00 mm (0.31 x 5.00 in.)				
7.94	127.00	8.38	9.52	17-4 PH Stainless: T-Handle - Industrial - Stainless Steel Part Number: BLP-079-1270-TI-S17
7.94	127.00	8.38	9.52	Alloy Steel / Aluminium Handle: T-Handle - Industrial - Steel and Aluminium Part Number: BLP-079-1270-TI-AC
7.94	127.00	8.38	9.52	Carbon Steel: Ring Handle - Industrial - Steel Part Number: BLP-079-1270-RHI-C
7.94	127.00	10.16	9.45	304 Stainless Steel: Marine Style - Half Ring Part Number: BLP-079-1270-MHR-S4
7.94	127.00	10.16	9.45	304 Stainless Steel: Marine Style - Recessed Head Part Number: BLP-079-1270-MRE-S4
7.94 x 152.40 mm (0.31 x 6.00 in.)				
7.94	152.40	8.38	9.52	17-4 PH Stainless: T-Handle - Industrial - Stainless Steel Part Number: BLP-079-1524-TI-S17



Usually stocked or Short Delivery
** Available while stocks last **

Long Delivery or Large Minimum Quantities
Not in current production

Ball Lock Pins



Nominal Pin Dia. A (mm)	Grip Length (mm)	End Distance C (mm)	Open Ball Distance B (mm)	
7.94 x 152.40 mm (0.31 x 6.00 in.)				
7.94	152.40	8.38	9.52	Carbon Steel: Ring Handle - Industrial - Steel Part Number: BLP-079-1524-RHI-C
7.94	152.40	10.16	9.45	304 Stainless Steel: Marine Style - Half Ring Part Number: BLP-079-1524-MHR-S4
8.00 x 15.00 mm (0.31 x 0.59 in.)				
8.00	15.00	8.00	9.42	17-4 PH Stainless / Aluminium Handle: T-Handle - Industrial - Stainless Steel and Aluminium Part Number: BLP-080-0150-TI-S17
8.00 x 25.00 mm (0.31 x 0.98 in.)				
8.00	25.00	8.00	9.42	17-4 PH Stainless / Aluminium Handle: T-Handle - Industrial - Stainless Steel and Aluminium Part Number: BLP-080-0250-TI-S17
8.00	25.00	8.00	9.42	Alloy Steel / Aluminium Handle: T-Handle - Industrial - Steel and Aluminium Part Number: BLP-080-0250-TI-AC
8.00 x 30.00 mm (0.31 x 1.18 in.)				
8.00	30.00	8.00	9.42	Alloy Steel / Aluminium Handle: T-Handle - Industrial - Steel and Aluminium Part Number: BLP-080-0300-TI-AC
8.00 x 40.00 mm (0.31 x 1.57 in.)				
8.00	40.00	8.00	9.42	17-4 PH Stainless / Aluminium Handle: T-Handle - Industrial - Stainless Steel and Aluminium Part Number: BLP-080-0400-TI-S17
8.00	40.00	8.00	9.42	Alloy Steel / Aluminium Handle: T-Handle - Industrial - Steel and Aluminium Part Number: BLP-080-0400-TI-AC
8.00 x 50.00 mm (0.31 x 1.97 in.)				
8.00	50.00	8.00	9.42	17-4 PH Stainless / Aluminium Handle: T-Handle - Industrial - Stainless Steel and Aluminium Part Number: BLP-080-0500-TI-S17
8.00	50.00	8.00	9.42	Alloy Steel / Aluminium Handle: T-Handle - Industrial - Steel and Aluminium Part Number: BLP-080-0500-TI-AC
8.00 x 75.00 mm (0.31 x 2.95 in.)				
8.00	75.00	8.00	9.42	17-4 PH Stainless / Aluminium Handle: T-Handle - Industrial - Stainless Steel and Aluminium Part Number: BLP-080-0750-TI-S17
8.00 x 100.00 mm (0.31 x 3.94 in.)				
8.00	100.00	8.00	9.42	Alloy Steel / Aluminium Handle: T-Handle - Industrial - Steel and Aluminium Part Number: BLP-080-1000-TI-AC
9.53 x 6.35 mm (0.38 x 0.25 in.)				
9.53	6.35	12.45	11.13	304 Stainless Steel: Marine Style - Half Ring Part Number: BLP-095-0064-MHR-S4
9.53	6.35	12.45	11.13	304 Stainless Steel: Marine Style - Recessed Head Part Number: BLP-095-0064-MRE-S4
9.53	6.35	12.70	10.82	304 Stainless Steel: Keyring Style - 300 Grade Stainless Steel - Dual Ball Part Number: BLP-095-0064-K2-S4
9.53	6.35	12.70	10.82	316 Stainless Steel: Keyring Style - 316 Stainless Steel Part Number: BLP-095-0064-K1-S6
9.53 x 12.70 mm (0.38 x 0.50 in.)				
9.53	12.70	9.27	11.17	Alloy Steel / Aluminium Handle: T-Handle - Industrial - Steel and Aluminium Part Number: BLP-095-0127-TI-AC
9.53	12.70	9.27	11.17	Carbon Steel: Button Handle - Steel Part Number: BLP-095-0127-BT-C
9.53	12.70	9.27	11.17	Carbon Steel: Ring Handle - Industrial - Steel Part Number: BLP-095-0127-RHI-C
9.53	12.70	9.27	11.18	17-4 PH or PH15-7MO shank with CRES440C spindle: High Tension - Industrial Part Number: BLP-095-0127-HTI-S17
9.53	12.70	9.27	11.18	304 Stainless Steel: T-Handle - Commercial - 304 Stainless Steel Part Number: BLP-095-0127-T-S4
9.53	12.70	9.27	11.18	304 Stainless Steel Shank / Aluminium Handle: Button Handle - Commercial - 304 Stainless Part Number: BLP-095-0127-BT-S4
9.53	12.70	9.27	11.18	Carbon Steel: Button Handle - Commercial - Carbon Steel Part Number: BLP-095-0127-BTC-C
9.53	12.70	9.27	11.18	Carbon Steel: T-Handle - Commercial - Carbon Steel Part Number: BLP-095-0127-TC-C



 Usually stocked or Short Delivery
 ** Available while stocks last **

 Long Delivery or Large Minimum Quantities
 Not in current production

Ball Lock Pins

Nominal Pin Dia. A (mm)	Grip Length (mm)	End Distance C (mm)	Open Ball Distance B (mm)	
9.53 x 12.70 mm (0.38 x 0.50 in.)				
9.53	12.70	10.80	11.13	Carbon Steel: Shackle Part Number: BLP-095-0127-SHK-C
9.53	12.70	12.45	11.13	17-4 PH Stainless: T-Handle - Stainless Steel - Heavy Duty Part Number: BLP-095-0127-THD-S17
9.53	12.70	12.45	11.13	304 Stainless Steel: Marine Style - Half Ring Part Number: BLP-095-0127-MHR-S4
9.53	12.70	12.45	11.13	304 Stainless Steel: Marine Style - Recessed Head Part Number: BLP-095-0127-MRE-S4
9.53	12.70	12.70	10.82	304 Stainless Steel: Keyring Style - 300 Grade Stainless Steel - Single Ball Part Number: BLP-095-0127-K1-S4
9.53	12.70	12.70	10.82	316 Stainless Steel: Keyring Style - 316 Stainless Steel Part Number: BLP-095-0127-K1-S6
9.53 x 15.24 mm (0.38 x 0.60 in.)				
9.53	15.24	12.70	10.82	Carbon Steel: Shoulder Type - Ring Handle Part Number: BLP-095-0152-RSH-C
9.53 x 19.05 mm (0.38 x 0.75 in.)				
9.53	19.05	9.27	11.17	17-4 PH Stainless / Aluminium Handle: Button Handle - Stainless Steel Part Number: BLP-095-0191-BT-S17
9.53	19.05	12.45	11.13	304 Stainless Steel: Marine Style - Half Ring Part Number: BLP-095-0191-MHR-S4
9.53	19.05	12.45	11.13	304 Stainless Steel: Marine Style - Recessed Head Part Number: BLP-095-0191-MRE-S4
9.53	19.05	12.70	10.82	304 Stainless Steel: Keyring Style - 300 Grade Stainless Steel - Dual Ball Part Number: BLP-095-0191-K2-S4
9.53	19.05	12.70	10.82	316 Stainless Steel: Keyring Style - 316 Stainless Steel Part Number: BLP-095-0191-K1-S6
9.53 x 20.32 mm (0.38 x 0.80 in.)				
9.53	20.32	12.70	10.82	303 Stainless Steel: Keyring Style - 300 Grade Stainless Steel - Single Ball Part Number: BLP-095-0203-K1-S3
9.53	20.32	12.70	10.82	Carbon Steel: Keyring Style - Steel Part Number: BLP-095-0203-K1-C
9.53 x 25.40 mm (0.38 x 1.00 in.)				
9.53	25.40	9.27	11.17	17-4 PH Stainless: Ring Handle - Industrial - Stainless Steel Part Number: BLP-095-0254-RHI-S17
9.53	25.40	9.27	11.17	17-4 PH Stainless: T-Handle - Industrial - Stainless Steel Part Number: BLP-095-0254-TI-S17
9.53	25.40	9.27	11.17	17-4 PH Stainless / Aluminium Handle: Button Handle - Stainless Steel Part Number: BLP-095-0254-BT-S17
9.53	25.40	9.27	11.17	Alloy Steel / Aluminium Handle: T-Handle - Industrial - Steel and Aluminium Part Number: BLP-095-0254-TI-AC
9.53	25.40	9.27	11.17	Carbon Steel: Button Handle - Steel Part Number: BLP-095-0254-BT-C
9.53	25.40	9.27	11.17	Carbon Steel: Ring Handle - Industrial - Steel Part Number: BLP-095-0254-RHI-C
9.53	25.40	9.27	11.17	Carbon steel with aluminium handle, stainless ball and ring.: L-Handle - Industrial - Steel Part Number: BLP-095-0254-LI-C
9.53	25.40	9.27	11.18	17-4 PH or PH15-7MO shank with CRES440C spindle: High Tension - Industrial Part Number: BLP-095-0254-HTI-S17
9.53	25.40	9.27	11.18	17-4 PH Stainless: Double Acting - T-Handle - Stainless Steel Part Number: BLP-095-0254-DT-S17
9.53	25.40	9.27	11.18	17-4 PH Stainless: L-Handle - Industrial - Stainless Steel Part Number: BLP-095-0254-LI-S17
9.53	25.40	9.27	11.18	304 Stainless Steel: T-Handle - Commercial - 304 Stainless Steel Part Number: BLP-095-0254-T-S4
9.53	25.40	9.27	11.18	304 Stainless Steel Shank / Aluminium Handle: Button Handle - Commercial - 304 Stainless Part Number: BLP-095-0254-BT-S4
9.53	25.40	9.27	11.18	Carbon Steel: Button Handle - Commercial - Carbon Steel Part Number: BLP-095-0254-BTC-C
9.53	25.40	9.27	11.18	Carbon Steel: T-Handle - Commercial - Carbon Steel Part Number: BLP-095-0254-TC-C

 Usually stocked or Short Delivery
 ** Available while stocks last **

 Long Delivery or Large Minimum Quantities
 Not in current production

Ball Lock Pins

Nominal Pin Dia. A (mm)	Grip Length (mm)	End Distance C (mm)	Open Ball Distance B (mm)	
9.53 x 25.40 mm (0.38 x 1.00 in.)				
9.53	25.40	12.45	11.13	17-4 PH Stainless: T-Handle - Stainless Steel - Heavy Duty Part Number: BLP-095-0254-THD-S17
9.53	25.40	12.45	11.13	304 Stainless Steel: Marine Style - Half Ring Part Number: BLP-095-0254-MHR-S4
9.53	25.40	12.45	11.13	304 Stainless Steel: Marine Style - Recessed Head Part Number: BLP-095-0254-MRE-S4
9.53	25.40	12.70	10.82	303 Stainless Steel: Keyring Style - 300 Grade Stainless Steel - Single Ball Part Number: BLP-095-0254-K1-S3
9.53	25.40	12.70	10.82	304 Stainless Steel: Keyring Style - 300 Grade Stainless Steel - Dual Ball Part Number: BLP-095-0254-K2-S4
9.53	25.40	12.70	10.82	316 Stainless Steel: Keyring Style - 316 Stainless Steel Part Number: BLP-095-0254-K1-S6
9.53	25.40	12.70	10.82	Carbon Steel: Keyring Style - Steel Part Number: BLP-095-0254-K1-C
9.53	25.40	12.70	10.82	Carbon Steel: Shoulder Type - Ring Handle Part Number: BLP-095-0254-RSH-C
9.53	25.40	12.70	10.82	Carbon Steel: Shoulder Type - T Handle Part Number: BLP-095-0254-TSH-C
9.53 x 31.75 mm (0.38 x 1.25 in.)				
9.53	31.75	9.27	11.17	17-4 PH Stainless / Aluminium Handle: Button Handle - Stainless Steel Part Number: BLP-095-0317-BT-S17
9.53	31.75	9.27	11.17	Carbon Steel: Ring Handle - Industrial - Steel Part Number: BLP-095-0317-RHI-C
9.53	31.75	12.45	11.13	304 Stainless Steel: Marine Style - Half Ring Part Number: BLP-095-0318-MHR-S4
9.53	31.75	12.45	11.13	304 Stainless Steel: Marine Style - Recessed Head Part Number: BLP-095-0318-MRE-S4
9.53	31.75	12.70	10.82	304 Stainless Steel: Keyring Style - 300 Grade Stainless Steel - Single Ball Part Number: BLP-095-0318-K1-S4
9.53	31.75	12.70	10.82	316 Stainless Steel: Keyring Style - 316 Stainless Steel Part Number: BLP-095-0318-K1-S6
9.53 x 33.02 mm (0.38 x 1.30 in.)				
9.53	33.02	12.70	10.82	303 Stainless Steel: Keyring Style - 300 Grade Stainless Steel - Single Ball Part Number: BLP-095-0330-K1-S3
9.53	33.02	12.70	10.82	Carbon Steel: Keyring Style - Steel Part Number: BLP-095-0330-K1-C
9.53 x 38.10 mm (0.38 x 1.50 in.)				
9.53	38.10	9.27	11.17	17-4 PH Stainless: Ring Handle - Industrial - Stainless Steel Part Number: BLP-095-0381-RHI-S17
9.53	38.10	9.27	11.17	17-4 PH Stainless: T-Handle - Industrial - Stainless Steel Part Number: BLP-095-0381-TI-S17
9.53	38.10	9.27	11.17	17-4 PH Stainless / Aluminium Handle: Button Handle - Stainless Steel Part Number: BLP-095-0381-BT-S17
9.53	38.10	9.27	11.17	Alloy Steel / Aluminium Handle: T-Handle - Industrial - Steel and Aluminium Part Number: BLP-095-0381-TI-AC
9.53	38.10	9.27	11.17	Carbon Steel: Button Handle - Steel Part Number: BLP-095-0381-BT-C
9.53	38.10	9.27	11.17	Carbon Steel: Ring Handle - Industrial - Steel Part Number: BLP-095-0381-RHI-C
9.53	38.10	9.27	11.17	Carbon steel with aluminium handle, stainless ball and ring.: L-Handle - Industrial - Steel Part Number: BLP-095-0381-LI-C
9.53	38.10	9.27	11.18	17-4 PH Stainless: Double Acting - Ring Handle - Stainless Steel Part Number: BLP-095-0381-DR-S17
9.53	38.10	9.27	11.18	17-4 PH Stainless: Double Acting - T-Handle - Stainless Steel Part Number: BLP-095-0381-DT-S17
9.53	38.10	9.27	11.18	17-4 PH Stainless: L-Handle - Industrial - Stainless Steel Part Number: BLP-095-0381-LI-S17
9.53	38.10	9.27	11.18	304 Stainless Steel: T-Handle - Commercial - 304 Stainless Steel Part Number: BLP-095-0381-T-S4
9.53	38.10	9.27	11.18	304 Stainless Steel Shank / Aluminium Handle: Button Handle - Commercial - 304 Stainless Part Number: BLP-095-0381-BT-S4

Usually stocked or Short Delivery
** Available while stocks last **

Long Delivery or Large Minimum Quantities
Not in current production

Ball Lock Pins

Nominal Pin Dia. A (mm)	Grip Length (mm)	End Distance C (mm)	Open Ball Distance B (mm)	
9.53 x 38.10 mm (0.38 x 1.50 in.)				
9.53	38.10	9.27	11.18	Carbon Steel: Button Handle - Commercial - Carbon Steel Part Number: BLP-095-0381-BTC-C
9.53	38.10	9.27	11.18	Carbon Steel: T-Handle - Commercial - Carbon Steel Part Number: BLP-095-0381-TC-C
9.53	38.10	12.45	11.13	17-4 PH Stainless: T-Handle - Stainless Steel - Heavy Duty Part Number: BLP-095-0381-THD-S17
9.53	38.10	12.45	11.13	304 Stainless Steel: Marine Style - Half Ring Part Number: BLP-095-0381-MHR-S4
9.53	38.10	12.45	11.13	304 Stainless Steel: Marine Style - Recessed Head Part Number: BLP-095-0381-MRE-S4
9.53	38.10	12.70	10.82	303 Stainless Steel: Keyring Style - 300 Grade Stainless Steel - Single Ball Part Number: BLP-095-0381-K1-S3
9.53	38.10	12.70	10.82	304 Stainless Steel: Keyring Style - 300 Grade Stainless Steel - Dual Ball Part Number: BLP-095-0381-K2-S4
9.53	38.10	12.70	10.82	316 Stainless Steel: Keyring Style - 316 Stainless Steel Part Number: BLP-095-0381-K1-S6
9.53	38.10	12.70	10.82	Carbon Steel: Keyring Style - Steel Part Number: BLP-095-0381-K1-C
9.53	38.10	12.70	10.82	Carbon Steel: Shoulder Type - Ring Handle Part Number: BLP-095-0381-RSH-C
9.53	38.10	12.70	10.82	Carbon Steel: Shoulder Type - T Handle Part Number: BLP-095-0381-TSH-C
9.53	38.10	12.70	10.82	Carbon Steel: T-Handle - Plastic Handle Part Number: BLP-095-0381-T-PC
9.53	38.10	12.70	10.82	Zinc Plated Carbon Steel: Ball Handle - Plastic Handle Part Number: BLP-095-0381-BL-C
9.53 x 44.45 mm (0.38 x 1.75 in.)				
9.53	44.45	9.27	11.17	Carbon Steel: Ring Handle - Industrial - Steel Part Number: BLP-095-0444-RHI-C
9.53	44.45	12.45	11.13	304 Stainless Steel: Marine Style - Half Ring Part Number: BLP-095-0445-MHR-S4
9.53	44.45	12.45	11.13	304 Stainless Steel: Marine Style - Recessed Head Part Number: BLP-095-0445-MRE-S4
9.53	44.45	12.70	10.82	304 Stainless Steel: Keyring Style - 300 Grade Stainless Steel - Dual Ball Part Number: BLP-095-0445-K2-S4
9.53	44.45	12.70	10.82	316 Stainless Steel: Keyring Style - 316 Stainless Steel Part Number: BLP-095-0445-K1-S6
9.53 x 45.72 mm (0.38 x 1.80 in.)				
9.53	45.72	12.70	10.82	Carbon Steel: Shoulder Type - Ring Handle Part Number: BLP-095-0457-RSH-C
9.53	45.72	12.70	10.82	Carbon Steel: Shoulder Type - T Handle Part Number: BLP-095-0457-TSH-C
9.53 x 50.80 mm (0.38 x 2.00 in.)				
9.53	50.80	9.27	11.17	17-4 PH Stainless: Ring Handle - Industrial - Stainless Steel Part Number: BLP-095-0508-RHI-S17
9.53	50.80	9.27	11.17	17-4 PH Stainless: T-Handle - Industrial - Stainless Steel Part Number: BLP-095-0508-TI-S17
9.53	50.80	9.27	11.17	17-4 PH Stainless / Aluminium Handle: Button Handle - Stainless Steel Part Number: BLP-095-0508-BT-S17
9.53	50.80	9.27	11.17	Alloy Steel / Aluminium Handle: T-Handle - Industrial - Steel and Aluminium Part Number: ** BLP-095-0508-TI-AC
9.53	50.80	9.27	11.17	Carbon Steel: Button Handle - Steel Part Number: BLP-095-0508-BT-C
9.53	50.80	9.27	11.17	Carbon Steel: Ring Handle - Industrial - Steel Part Number: BLP-095-0508-RHI-C
9.53	50.80	9.27	11.17	Carbon steel with aluminium handle, stainless ball and ring.: L-Handle - Industrial - Steel Part Number: BLP-095-0508-LI-C
9.53	50.80	9.27	11.18	17-4 PH or PH15-7MO shank with CRES440C spindle: High Tension - Industrial Part Number: BLP-095-0508-HTI-S17
9.53	50.80	9.27	11.18	17-4 PH Stainless: Double Acting - L-Handle - Stainless Steel Part Number: BLP-095-0508-DL-S17

Usually stocked or Short Delivery
** Available while stocks last **

Long Delivery or Large Minimum Quantities
Not in current production

Ball Lock Pins



Nominal Pin Dia. A (mm)	Grip Length (mm)	End Distance C (mm)	Open Ball Distance B (mm)	
9.53 x 50.80 mm		<i>(0.38 x 2.00 in.)</i>		
9.53	50.80	9.27	11.18	17-4 PH Stainless: Double Acting - Ring Handle - Stainless Steel Part Number: BLP-095-0508-DR-S17
9.53	50.80	9.27	11.18	17-4 PH Stainless: Double Acting - T-Handle - Stainless Steel Part Number: BLP-095-0508-DT-S17
9.53	50.80	9.27	11.18	17-4 PH Stainless: L-Handle - Industrial - Stainless Steel Part Number: BLP-095-0508-LI-S17
9.53	50.80	9.27	11.18	304 Stainless Steel: T-Handle - Commercial - 304 Stainless Steel Part Number: BLP-095-0508-T-S4
9.53	50.80	9.27	11.18	304 Stainless Steel Shank / Aluminium Handle: Button Handle - Commercial - 304 Stainless Part Number: BLP-095-0508-BT-S4
9.53	50.80	9.27	11.18	Carbon Steel: Button Handle - Commercial - Carbon Steel Part Number: BLP-095-0508-BTC-C
9.53	50.80	9.27	11.18	Carbon Steel: T-Handle - Commercial - Carbon Steel Part Number: BLP-095-0508-TC-C
9.53	50.80	10.80	11.13	Carbon Steel: Shackle Part Number: BLP-095-0508-SHK-C
9.53	50.80	12.45	11.13	17-4 PH Stainless: T-Handle - Stainless Steel - Heavy Duty Part Number: BLP-095-0508-THD-S17
9.53	50.80	12.45	11.13	304 Stainless Steel: Marine Style - Half Ring Part Number: BLP-095-0508-MHR-S4
9.53	50.80	12.45	11.13	304 Stainless Steel: Marine Style - Recessed Head Part Number: BLP-095-0508-MRE-S4
9.53	50.80	12.70	10.82	303 Stainless Steel: Keyring Style - 300 Grade Stainless Steel - Single Ball Part Number: BLP-095-0508-K1-S3
9.53	50.80	12.70	10.82	304 Stainless Steel: Keyring Style - 300 Grade Stainless Steel - Dual Ball Part Number: BLP-095-0508-K2-S4
9.53	50.80	12.70	10.82	316 Stainless Steel: Keyring Style - 316 Stainless Steel Part Number: BLP-095-0508-K1-S6
9.53	50.80	12.70	10.82	Carbon Steel: Keyring Style - Steel Part Number: BLP-095-0508-K1-C
9.53	50.80	12.70	10.82	Carbon Steel: Shoulder Type - Ring Handle Part Number: BLP-095-0508-RSH-C
9.53	50.80	12.70	10.82	Carbon Steel: Shoulder Type - T Handle Part Number: BLP-095-0508-TSH-C
9.53	50.80	12.70	10.82	Carbon Steel: T-Handle - Plastic Handle Part Number: BLP-095-0508-T-PC
9.53	50.80	12.70	10.82	Zinc Plated Carbon Steel: Ball Handle - Plastic Handle Part Number: BLP-095-0508-BL-C
9.53 x 57.15 mm		<i>(0.38 x 2.25 in.)</i>		
9.53	57.15	9.27	11.17	Carbon Steel: Ring Handle - Industrial - Steel Part Number: BLP-095-0572-RHI-C
9.53	57.15	12.45	11.13	304 Stainless Steel: Marine Style - Recessed Head Part Number: BLP-095-0572-MRE-S4
9.53	57.15	12.70	10.82	304 Stainless Steel: Keyring Style - 300 Grade Stainless Steel - Dual Ball Part Number: BLP-095-0572-K2-S4
9.53	57.15	12.70	10.82	316 Stainless Steel: Keyring Style - 316 Stainless Steel Part Number: BLP-095-0572-K1-S6
9.53 x 63.50 mm		<i>(0.38 x 2.50 in.)</i>		
9.53	63.50	9.27	11.17	17-4 PH Stainless: Ring Handle - Industrial - Stainless Steel Part Number: BLP-095-0635-RHI-S17
9.53	63.50	9.27	11.17	17-4 PH Stainless: T-Handle - Industrial - Stainless Steel Part Number: BLP-095-0635-TI-S17
9.53	63.50	9.27	11.17	17-4 PH Stainless / Aluminium Handle: Button Handle - Stainless Steel Part Number: BLP-095-0635-BT-S17
9.53	63.50	9.27	11.17	Alloy Steel / Aluminium Handle: T-Handle - Industrial - Steel and Aluminium Part Number: BLP-095-0635-TI-AC
9.53	63.50	9.27	11.17	Carbon Steel: Button Handle - Steel Part Number: BLP-095-0635-BT-C
9.53	63.50	9.27	11.17	Carbon Steel: Ring Handle - Industrial - Steel Part Number: BLP-095-0635-RHI-C



Usually stocked or Short Delivery
 ** Available while stocks last **

Long Delivery or Large Minimum Quantities
 Not in current production

Ball Lock Pins



Nominal Pin Dia. A (mm)	Grip Length (mm)	End Distance C (mm)	Open Ball Distance B (mm)	
9.53 x 63.50 mm		<i>(0.38 x 2.50 in.)</i>		
9.53	63.50	9.27	11.17	Carbon steel with aluminium handle, stainless ball and ring.: L-Handle - Industrial - Steel Part Number: BLP-095-0635-LI-C
9.53	63.50	9.27	11.18	17-4 PH Stainless: Double Acting - T-Handle - Stainless Steel Part Number: BLP-095-0635-DT-S17
9.53	63.50	9.27	11.18	17-4 PH Stainless: L-Handle - Industrial - Stainless Steel Part Number: BLP-095-0635-LI-S17
9.53	63.50	9.27	11.18	304 Stainless Steel: T-Handle - Commercial - 304 Stainless Steel Part Number: BLP-095-0635-T-S4
9.53	63.50	9.27	11.18	304 Stainless Steel Shank / Aluminium Handle: Button Handle - Commercial - 304 Stainless Part Number: BLP-095-0635-BT-S4
9.53	63.50	9.27	11.18	Carbon Steel: Button Handle - Commercial - Carbon Steel Part Number: BLP-095-0635-BTC-C
9.53	63.50	9.27	11.18	Carbon Steel: T-Handle - Commercial - Carbon Steel Part Number: BLP-095-0635-TC-C
9.53	63.50	12.45	11.13	17-4 PH Stainless: T-Handle - Stainless Steel - Heavy Duty Part Number: BLP-095-0635-THD-S17
9.53	63.50	12.45	11.13	304 Stainless Steel: Marine Style - Half Ring Part Number: BLP-095-0635-MHR-S4
9.53	63.50	12.45	11.13	304 Stainless Steel: Marine Style - Recessed Head Part Number: BLP-095-0635-MRE-S4
9.53	63.50	12.70	10.82	303 Stainless Steel: Keyring Style - 300 Grade Stainless Steel - Single Ball Part Number: BLP-095-0635-K1-S3
9.53	63.50	12.70	10.82	304 Stainless Steel: Keyring Style - 300 Grade Stainless Steel - Dual Ball Part Number: BLP-095-0635-K2-S4
9.53	63.50	12.70	10.82	316 Stainless Steel: Keyring Style - 316 Stainless Steel Part Number: BLP-095-0635-K1-S6
9.53	63.50	12.70	10.82	Carbon Steel: Keyring Style - Steel Part Number: BLP-095-0635-K1-C
9.53	63.50	12.70	10.82	Carbon Steel: Shoulder Type - Ring Handle Part Number: BLP-095-0635-RSH-C
9.53	63.50	12.70	10.82	Carbon Steel: Shoulder Type - T Handle Part Number: BLP-095-0635-TSH-C
9.53	63.50	12.70	10.82	Carbon Steel: T-Handle - Plastic Handle Part Number: BLP-095-0635-T-PC
9.53 x 69.85 mm		<i>(0.38 x 2.75 in.)</i>		
9.53	69.85	12.45	11.13	304 Stainless Steel: Marine Style - Half Ring Part Number: BLP-095-0699-MHR-S4
9.53	69.85	12.45	11.13	304 Stainless Steel: Marine Style - Recessed Head Part Number: BLP-095-0699-MRE-S4
9.53	69.85	12.70	10.82	304 Stainless Steel: Keyring Style - 300 Grade Stainless Steel - Dual Ball Part Number: BLP-095-0699-K2-S4
9.53	69.85	12.70	10.82	316 Stainless Steel: Keyring Style - 316 Stainless Steel Part Number: BLP-095-0699-K1-S6
9.53 x 76.20 mm		<i>(0.38 x 3.00 in.)</i>		
9.53	76.20	9.27	11.17	17-4 PH Stainless: Ring Handle - Industrial - Stainless Steel Part Number: BLP-095-0762-RHI-S17
9.53	76.20	9.27	11.17	17-4 PH Stainless: T-Handle - Industrial - Stainless Steel Part Number: BLP-095-0762-TI-S17
9.53	76.20	9.27	11.17	17-4 PH Stainless / Aluminium Handle: Button Handle - Stainless Steel Part Number: BLP-095-0762-BT-S17
9.53	76.20	9.27	11.17	Alloy Steel / Aluminium Handle: T-Handle - Industrial - Steel and Aluminium Part Number: BLP-095-0762-TI-AC
9.53	76.20	9.27	11.17	Carbon Steel: Button Handle - Steel Part Number: BLP-095-0762-BT-C
9.53	76.20	9.27	11.17	Carbon Steel: Ring Handle - Industrial - Steel Part Number: BLP-095-0762-RHI-C
9.53	76.20	9.27	11.17	Carbon steel with aluminium handle, stainless ball and ring.: L-Handle - Industrial - Steel Part Number: BLP-095-0762-LI-C
9.53	76.20	9.27	11.18	17-4 PH or PH15-7MO shank with CRES440C spindle: High Tension - Industrial Part Number: BLP-095-0762-HTI-S17



 Usually stocked or Short Delivery
 ** Available while stocks last **

 Long Delivery or Large Minimum Quantities
 Not in current production

Ball Lock Pins

Nominal Pin Dia. A (mm)	Grip Length (mm)	End Distance C (mm)	Open Ball Distance B (mm)	
9.53 x 76.20 mm		<i>(0.38 x 3.00 in.)</i>		
9.53	76.20	9.27	11.18	17-4 PH Stainless: Double Acting - T-Handle - Stainless Steel Part Number: BLP-095-0762-DT-S17
9.53	76.20	9.27	11.18	17-4 PH Stainless: L-Handle - Industrial - Stainless Steel Part Number: BLP-095-0762-LI-S17
9.53	76.20	9.27	11.18	304 Stainless Steel: T-Handle - Commercial - 304 Stainless Steel Part Number: BLP-095-0762-T-S4
9.53	76.20	9.27	11.18	304 Stainless Steel Shank / Aluminium Handle: Button Handle - Commercial - 304 Stainless Part Number: BLP-095-0762-BT-S4
9.53	76.20	9.27	11.18	Carbon Steel: Button Handle - Commercial - Carbon Steel Part Number: BLP-095-0762-BTC-C
9.53	76.20	9.27	11.18	Carbon Steel: T-Handle - Commercial - Carbon Steel Part Number: BLP-095-0762-TC-C
9.53	76.20	12.45	11.13	17-4 PH Stainless: T-Handle - Stainless Steel - Heavy Duty Part Number: BLP-095-0762-THD-S17
9.53	76.20	12.45	11.13	304 Stainless Steel: Marine Style - Half Ring Part Number: BLP-095-0762-MHR-S4
9.53	76.20	12.45	11.13	304 Stainless Steel: Marine Style - Recessed Head Part Number: BLP-095-0762-MRE-S4
9.53	76.20	12.70	10.82	303 Stainless Steel: Keyring Style - 300 Grade Stainless Steel - Single Ball Part Number: BLP-095-0762-K1-S3
9.53	76.20	12.70	10.82	304 Stainless Steel: Keyring Style - 300 Grade Stainless Steel - Dual Ball Part Number: BLP-095-0762-K2-S4
9.53	76.20	12.70	10.82	316 Stainless Steel: Keyring Style - 316 Stainless Steel Part Number: BLP-095-0762-K1-S6
9.53	76.20	12.70	10.82	Carbon Steel: Keyring Style - Steel Part Number: BLP-095-0762-K1-C
9.53	76.20	12.70	10.82	Carbon Steel: Shoulder Type - Ring Handle Part Number: BLP-095-0762-RSH-C
9.53	76.20	12.70	10.82	Carbon Steel: Shoulder Type - T Handle Part Number: BLP-095-0762-TSH-C
9.53	76.20	12.70	10.82	Zinc Plated Carbon Steel: Ball Handle - Plastic Handle Part Number: BLP-095-0762-BL-C
9.53 x 82.55 mm		<i>(0.38 x 3.25 in.)</i>		
9.53	82.55	12.45	11.13	304 Stainless Steel: Marine Style - Half Ring Part Number: BLP-095-0826-MHR-S4
9.53	82.55	12.45	11.13	304 Stainless Steel: Marine Style - Recessed Head Part Number: BLP-095-0826-MRE-S4
9.53	82.55	12.70	10.82	304 Stainless Steel: Keyring Style - 300 Grade Stainless Steel - Dual Ball Part Number: BLP-095-0826-K2-S4
9.53	82.55	12.70	10.82	316 Stainless Steel: Keyring Style - 316 Stainless Steel Part Number: BLP-095-0826-K1-S6
9.53 x 88.90 mm		<i>(0.38 x 3.50 in.)</i>		
9.53	88.90	9.27	11.17	17-4 PH Stainless: T-Handle - Industrial - Stainless Steel Part Number: BLP-095-0889-TI-S17
9.53	88.90	9.27	11.17	17-4 PH Stainless / Aluminium Handle: Button Handle - Stainless Steel Part Number: BLP-095-0889-BT-S17
9.53	88.90	9.27	11.17	Alloy Steel / Aluminium Handle: T-Handle - Industrial - Steel and Aluminium Part Number: BLP-095-0889-TI-AC
9.53	88.90	9.27	11.17	Carbon Steel: Button Handle - Steel Part Number: BLP-095-0889-BT-C
9.53	88.90	9.27	11.17	Carbon Steel: Ring Handle - Industrial - Steel Part Number: BLP-095-0889-RHI-C
9.53	88.90	9.27	11.17	Carbon steel with aluminium handle, stainless ball and ring.: L-Handle - Industrial - Steel Part Number: BLP-095-0889-LI-C
9.53	88.90	9.27	11.18	17-4 PH Stainless: L-Handle - Industrial - Stainless Steel Part Number: BLP-095-0889-LI-S17
9.53	88.90	9.27	11.18	304 Stainless Steel: T-Handle - Commercial - 304 Stainless Steel Part Number: BLP-095-0889-T-S4
9.53	88.90	9.27	11.18	304 Stainless Steel Shank / Aluminium Handle: Button Handle - Commercial - 304 Stainless Part Number: BLP-095-0889-BT-S4

 Usually stocked or Short Delivery
 ** Available while stocks last **

 Long Delivery or Large Minimum Quantities
 Not in current production

Ball Lock Pins

Nominal Pin Dia. A (mm)	Grip Length (mm)	End Distance C (mm)	Open Ball Distance B (mm)	
9.53 x 88.90 mm (0.38 x 3.50 in.)				
9.53	88.90	9.27	11.18	Carbon Steel: Button Handle - Commercial - Carbon Steel Part Number: BLP-095-0889-BTC-C
9.53	88.90	9.27	11.18	Carbon Steel: T-Handle - Commercial - Carbon Steel Part Number: BLP-095-0889-TC-C
9.53	88.90	12.45	11.13	17-4 PH Stainless: T-Handle - Stainless Steel - Heavy Duty Part Number: BLP-095-0889-THD-S17
9.53	88.90	12.45	11.13	304 Stainless Steel: Marine Style - Half Ring Part Number: BLP-095-0889-MHR-S4
9.53	88.90	12.45	11.13	304 Stainless Steel: Marine Style - Recessed Head Part Number: BLP-095-0889-MRE-S4
9.53	88.90	12.70	10.82	303 Stainless Steel: Keyring Style - 300 Grade Stainless Steel - Single Ball Part Number: BLP-095-0889-K1-S3
9.53	88.90	12.70	10.82	304 Stainless Steel: Keyring Style - 300 Grade Stainless Steel - Dual Ball Part Number: BLP-095-0889-K2-S4
9.53	88.90	12.70	10.82	316 Stainless Steel: Keyring Style - 316 Stainless Steel Part Number: BLP-095-0889-K1-S6
9.53	88.90	12.70	10.82	Carbon Steel: Keyring Style - Steel Part Number: BLP-095-0889-K1-C
9.53	88.90	12.70	10.82	Carbon Steel: T-Handle - Plastic Handle Part Number: BLP-095-0889-T-PC
9.53 x 95.25 mm (0.38 x 3.75 in.)				
9.53	95.25	12.45	11.13	304 Stainless Steel: Marine Style - Half Ring Part Number: BLP-095-0953-MHR-S4
9.53	95.25	12.45	11.13	304 Stainless Steel: Marine Style - Recessed Head Part Number: BLP-095-0953-MRE-S4
9.53	95.25	12.70	10.82	304 Stainless Steel: Keyring Style - 300 Grade Stainless Steel - Dual Ball Part Number: BLP-095-0953-K2-S4
9.53	95.25	12.70	10.82	316 Stainless Steel: Keyring Style - 316 Stainless Steel Part Number: BLP-095-0953-K1-S6
9.53 x 101.60 mm (0.38 x 4.00 in.)				
9.53	101.60	9.27	11.17	17-4 PH Stainless: T-Handle - Industrial - Stainless Steel Part Number: BLP-095-1016-TI-S17
9.53	101.60	9.27	11.17	17-4 PH Stainless / Aluminium Handle: Button Handle - Stainless Steel Part Number: BLP-095-1016-BT-S17
9.53	101.60	9.27	11.17	Alloy Steel / Aluminium Handle: T-Handle - Industrial - Steel and Aluminium Part Number: BLP-095-1016-TI-AC
9.53	101.60	9.27	11.17	Carbon Steel: Button Handle - Steel Part Number: BLP-095-1016-BT-C
9.53	101.60	9.27	11.17	Carbon Steel: Ring Handle - Industrial - Steel Part Number: BLP-095-1016-RHI-C
9.53	101.60	9.27	11.17	Carbon steel with aluminium handle, stainless ball and ring.: L-Handle - Industrial - Steel Part Number: BLP-095-1016-LI-C
9.53	101.60	9.27	11.18	17-4 PH or PH15-7MO shank with CRES440C spindle: High Tension - Industrial Part Number: BLP-095-1016-HTI-S17
9.53	101.60	9.27	11.18	17-4 PH Stainless: L-Handle - Industrial - Stainless Steel Part Number: BLP-095-1016-LI-S17
9.53	101.60	9.27	11.18	304 Stainless Steel: T-Handle - Commercial - 304 Stainless Steel Part Number: BLP-095-1016-T-S4
9.53	101.60	9.27	11.18	304 Stainless Steel Shank / Aluminium Handle: Button Handle - Commercial - 304 Stainless Part Number: BLP-095-1016-BT-S4
9.53	101.60	9.27	11.18	Carbon Steel: Button Handle - Commercial - Carbon Steel Part Number: BLP-095-1016-BTC-C
9.53	101.60	9.27	11.18	Carbon Steel: T-Handle - Commercial - Carbon Steel Part Number: BLP-095-1016-TC-C
9.53	101.60	12.45	11.13	17-4 PH Stainless: T-Handle - Stainless Steel - Heavy Duty Part Number: BLP-095-1016-THD-S17
9.53	101.60	12.45	11.13	304 Stainless Steel: Marine Style - Half Ring Part Number: BLP-095-1016-MHR-S4
9.53	101.60	12.70	10.82	303 Stainless Steel: Keyring Style - 300 Grade Stainless Steel - Single Ball Part Number: BLP-095-1016-K1-S3
9.53	101.60	12.70	10.82	304 Stainless Steel: Keyring Style - 300 Grade Stainless Steel - Dual Ball Part Number: BLP-095-1016-K2-S4

Usually stocked or Short Delivery
** Available while stocks last **

Long Delivery or Large Minimum Quantities
Not in current production

Ball Lock Pins



Nominal Pin Dia. A (mm)	Grip Length (mm)	End Distance C (mm)	Open Ball Distance B (mm)	
9.53 x 101.60 mm (0.38 x 4.00 in.)				
9.53	101.60	12.70	10.82	316 Stainless Steel: Keyring Style - 316 Stainless Steel Part Number: BLP-095-1016-K1-S6
9.53	101.60	12.70	10.82	Carbon Steel: Keyring Style - Steel Part Number: BLP-095-1016-K1-C
9.53	101.60	12.70	10.82	Carbon Steel: Shoulder Type - Ring Handle Part Number: BLP-095-1016-RSH-C
9.53	101.60	12.70	10.82	Carbon Steel: Shoulder Type - T Handle Part Number: BLP-095-1016-TSH-C
9.53	101.60	12.70	10.82	Carbon Steel: T-Handle - Plastic Handle Part Number: BLP-095-1016-T-PC
9.53	101.60	12.70	10.82	Zinc Plated Carbon Steel: Ball Handle - Plastic Handle Part Number: BLP-095-1016-BL-C
9.53 x 107.95 mm (0.38 x 4.25 in.)				
9.53	107.95	12.45	11.13	304 Stainless Steel: Marine Style - Half Ring Part Number: BLP-095-1080-MHR-S4
9.53	107.95	12.45	11.13	304 Stainless Steel: Marine Style - Recessed Head Part Number: BLP-095-1080-MRE-S4
9.53	107.95	12.70	10.82	304 Stainless Steel: Keyring Style - 300 Grade Stainless Steel - Dual Ball Part Number: BLP-095-1080-K2-S4
9.53	107.95	12.70	10.82	316 Stainless Steel: Keyring Style - 316 Stainless Steel Part Number: BLP-095-1080-K1-S6
9.53 x 114.30 mm (0.38 x 4.50 in.)				
9.53	114.30	9.27	11.17	17-4 PH Stainless: T-Handle - Industrial - Stainless Steel Part Number: BLP-095-1143-TI-S17
9.53	114.30	9.27	11.17	17-4 PH Stainless / Aluminium Handle: Button Handle - Stainless Steel Part Number: BLP-095-1143-BT-S17
9.53	114.30	9.27	11.17	Alloy Steel / Aluminium Handle: T-Handle - Industrial - Steel and Aluminium Part Number: BLP-095-1143-TI-AC
9.53	114.30	9.27	11.17	Carbon Steel: Button Handle - Steel Part Number: BLP-095-1143-BT-C
9.53	114.30	9.27	11.17	Carbon Steel: Ring Handle - Industrial - Steel Part Number: BLP-095-1143-RHI-C
9.53	114.30	9.27	11.17	Carbon steel with aluminium handle, stainless ball and ring.: L-Handle - Industrial - Steel Part Number: BLP-095-1143-LI-C
9.53	114.30	9.27	11.18	17-4 PH Stainless: L-Handle - Industrial - Stainless Steel Part Number: BLP-095-1143-LI-S17
9.53	114.30	12.45	11.13	17-4 PH Stainless: T-Handle - Stainless Steel - Heavy Duty Part Number: BLP-095-1143-THD-S17
9.53	114.30	12.45	11.13	304 Stainless Steel: Marine Style - Half Ring Part Number: BLP-095-1143-MHR-S4
9.53	114.30	12.45	11.13	304 Stainless Steel: Marine Style - Recessed Head Part Number: BLP-095-1143-MRE-S4
9.53	114.30	12.70	10.82	303 Stainless Steel: Keyring Style - 300 Grade Stainless Steel - Single Ball Part Number: BLP-095-1143-K1-S3
9.53	114.30	12.70	10.82	304 Stainless Steel: Keyring Style - 300 Grade Stainless Steel - Dual Ball Part Number: BLP-095-1143-K2-S4
9.53	114.30	12.70	10.82	316 Stainless Steel: Keyring Style - 316 Stainless Steel Part Number: BLP-095-1143-K1-S6
9.53	114.30	12.70	10.82	Carbon Steel: Keyring Style - Steel Part Number: BLP-095-1143-K1-C
9.53 x 120.65 mm (0.38 x 4.75 in.)				
9.53	120.65	12.45	11.13	304 Stainless Steel: Marine Style - Half Ring Part Number: BLP-095-1207-MHR-S4
9.53	120.65	12.45	11.13	304 Stainless Steel: Marine Style - Recessed Head Part Number: BLP-095-1207-MRE-S4
9.53	120.65	12.70	10.82	304 Stainless Steel: Keyring Style - 300 Grade Stainless Steel - Dual Ball Part Number: BLP-095-1207-K2-S4
9.53	120.65	12.70	10.82	316 Stainless Steel: Keyring Style - 316 Stainless Steel Part Number: BLP-095-1207-K1-S6



Usually stocked or Short Delivery
** Available while stocks last **

Long Delivery or Large Minimum Quantities
Not in current production

Ball Lock Pins



Nominal Pin Dia. A (mm)	Grip Length (mm)	End Distance C (mm)	Open Ball Distance B (mm)	
9.53 x 127.00 mm (0.38 x 5.00 in.)				
9.53	127.00	9.27	11.17	17-4 PH Stainless: T-Handle - Industrial - Stainless Steel Part Number: BLP-095-1270-TI-S17
9.53	127.00	9.27	11.17	17-4 PH Stainless / Aluminium Handle: Button Handle - Stainless Steel Part Number: BLP-095-1270-BT-S17
9.53	127.00	9.27	11.17	Alloy Steel / Aluminium Handle: T-Handle - Industrial - Steel and Aluminium Part Number: BLP-095-1270-TI-AC
9.53	127.00	9.27	11.17	Carbon Steel: Button Handle - Steel Part Number: BLP-095-1270-BT-C
9.53	127.00	9.27	11.17	Carbon Steel: Ring Handle - Industrial - Steel Part Number: BLP-095-1270-RHI-C
9.53	127.00	9.27	11.17	Carbon steel with aluminium handle, stainless ball and ring.: L-Handle - Industrial - Steel Part Number: BLP-095-1270-LI-C
9.53	127.00	9.27	11.18	17-4 PH Stainless: Double Acting - Ring Handle - Stainless Steel Part Number: BLP-095-1270-DR-S17
9.53	127.00	12.45	11.13	304 Stainless Steel: Marine Style - Half Ring Part Number: BLP-095-1270-MHR-S4
9.53	127.00	12.45	11.13	304 Stainless Steel: Marine Style - Recessed Head Part Number: BLP-095-1270-MRE-S4
9.53	127.00	12.70	10.82	303 Stainless Steel: Keyring Style - 300 Grade Stainless Steel - Single Ball Part Number: BLP-095-1270-K1-S3
9.53	127.00	12.70	10.82	304 Stainless Steel: Keyring Style - 300 Grade Stainless Steel - Dual Ball Part Number: BLP-095-1270-K2-S4
9.53	127.00	12.70	10.82	316 Stainless Steel: Keyring Style - 316 Stainless Steel Part Number: BLP-095-1270-K1-S6
9.53	127.00	12.70	10.82	Carbon Steel: Keyring Style - Steel Part Number: BLP-095-1270-K1-C
9.53 x 139.70 mm (0.38 x 5.50 in.)				
9.53	139.70	9.27	11.17	17-4 PH Stainless / Aluminium Handle: Button Handle - Stainless Steel Part Number: BLP-095-1397-BT-S17
9.53	139.70	9.27	11.17	Alloy Steel / Aluminium Handle: T-Handle - Industrial - Steel and Aluminium Part Number: BLP-095-1397-TI-AC
9.53	139.70	9.27	11.17	Carbon Steel: Ring Handle - Industrial - Steel Part Number: BLP-095-1397-RHI-C
9.53 x 152.40 mm (0.38 x 6.00 in.)				
9.53	152.40	9.27	11.17	17-4 PH Stainless: T-Handle - Industrial - Stainless Steel Part Number: BLP-095-1524-TI-S17
9.53	152.40	9.27	11.17	Alloy Steel / Aluminium Handle: T-Handle - Industrial - Steel and Aluminium Part Number: BLP-095-1524-TI-AC
9.53	152.40	9.27	11.17	Carbon Steel: Ring Handle - Industrial - Steel Part Number: BLP-095-1524-RHI-C
9.53	152.40	12.45	11.13	304 Stainless Steel: Marine Style - Recessed Head Part Number: BLP-095-1524-MRE-S4
10.00 x 15.00 mm (0.39 x 0.59 in.)				
10.00	15.00	9.00	11.86	17-4 PH Stainless / Aluminium Handle: T-Handle - Industrial - Stainless Steel and Aluminium Part Number: BLP-100-0150-TI-S17
10.00 x 20.00 mm (0.39 x 0.79 in.)				
10.00	20.00	9.00	11.86	17-4 PH Stainless / Aluminium Handle: T-Handle - Industrial - Stainless Steel and Aluminium Part Number: BLP-100-0200-TI-S17
10.00 x 25.00 mm (0.39 x 0.98 in.)				
10.00	25.00	9.00	11.86	17-4 PH Stainless / Aluminium Handle: T-Handle - Industrial - Stainless Steel and Aluminium Part Number: BLP-100-0250-TI-S17
10.00	25.00	9.00	11.86	Alloy Steel / Aluminium Handle: T-Handle - Industrial - Steel and Aluminium Part Number: BLP-100-0250-TI-AC
10.00 x 30.00 mm (0.39 x 1.18 in.)				
10.00	30.00	9.00	11.86	Alloy Steel / Aluminium Handle: T-Handle - Industrial - Steel and Aluminium Part Number: BLP-100-0300-TI-AC
10.00 x 40.00 mm (0.39 x 1.57 in.)				
10.00	40.00	9.00	11.86	17-4 PH Stainless / Aluminium Handle: T-Handle - Industrial - Stainless Steel and Aluminium Part Number: BLP-100-0400-TI-S17



 Usually stocked or Short Delivery
 ** Available while stocks last **

 Long Delivery or Large Minimum Quantities
 Not in current production

Ball Lock Pins



Nominal Pin Dia. A (mm)	Grip Length (mm)	End Distance C (mm)	Open Ball Distance B (mm)	
10.00 x 40.00 mm (0.39 x 1.57 in.)				
10.00	40.00	9.00	11.86	Alloy Steel / Aluminium Handle: T-Handle - Industrial - Steel and Aluminium Part Number: BLP-100-0400-TI-AC
10.00 x 50.00 mm (0.39 x 1.97 in.)				
10.00	50.00	9.00	11.86	17-4 PH Stainless / Aluminium Handle: T-Handle - Industrial - Stainless Steel and Aluminium Part Number: BLP-100-0500-TI-S17
10.00	50.00	9.00	11.86	Alloy Steel / Aluminium Handle: T-Handle - Industrial - Steel and Aluminium Part Number: BLP-100-0500-TI-AC
10.00 x 65.00 mm (0.39 x 2.56 in.)				
10.00	65.00	9.00	11.86	17-4 PH Stainless / Aluminium Handle: T-Handle - Industrial - Stainless Steel and Aluminium Part Number: BLP-100-0650-TI-S17
10.00 x 75.00 mm (0.39 x 2.95 in.)				
10.00	75.00	9.00	11.86	17-4 PH Stainless / Aluminium Handle: T-Handle - Industrial - Stainless Steel and Aluminium Part Number: BLP-100-0750-TI-S17
10.00 x 100.00 mm (0.39 x 3.94 in.)				
10.00	100.00	9.00	11.86	17-4 PH Stainless / Aluminium Handle: T-Handle - Industrial - Stainless Steel and Aluminium Part Number: BLP-100-1000-TI-S17
10.00	100.00	9.00	11.86	Alloy Steel / Aluminium Handle: T-Handle - Industrial - Steel and Aluminium Part Number: BLP-100-1000-TI-AC
11.11 x 25.40 mm (0.44 x 1.00 in.)				
11.11	25.40	9.65	12.92	17-4 PH Stainless: T-Handle - Industrial - Stainless Steel Part Number: BLP-111-0254-TI-S17
11.11	25.40	9.65	12.92	Alloy Steel / Aluminium Handle: T-Handle - Industrial - Steel and Aluminium Part Number: BLP-111-0254-TI-AC
11.11 x 38.10 mm (0.44 x 1.50 in.)				
11.11	38.10	9.65	12.92	17-4 PH Stainless: T-Handle - Industrial - Stainless Steel Part Number: BLP-111-0381-TI-S17
11.11	38.10	9.65	12.92	Alloy Steel / Aluminium Handle: T-Handle - Industrial - Steel and Aluminium Part Number: BLP-111-0381-TI-AC
11.11	38.10	9.65	12.92	Carbon Steel: Button Handle - Steel Part Number: BLP-111-0381-BT-C
11.11	38.10	9.65	12.92	Carbon steel with aluminium handle, stainless ball and ring.: L-Handle - Industrial - Steel Part Number: BLP-111-0381-LI-C
11.11 x 50.80 mm (0.44 x 2.00 in.)				
11.11	50.80	9.65	12.92	17-4 PH Stainless: T-Handle - Industrial - Stainless Steel Part Number: BLP-111-0508-TI-S17
11.11	50.80	9.65	12.92	17-4 PH Stainless / Aluminium Handle: Button Handle - Stainless Steel Part Number: BLP-111-0508-BT-S17
11.11	50.80	9.65	12.92	Alloy Steel / Aluminium Handle: T-Handle - Industrial - Steel and Aluminium Part Number: BLP-111-0508-TI-AC
11.11	50.80	9.65	12.92	Carbon Steel: Button Handle - Steel Part Number: BLP-111-0508-BT-C
11.11	50.80	9.65	12.92	Carbon Steel: Ring Handle - Industrial - Steel Part Number: BLP-111-0508-RHI-C
11.11	50.80	9.65	12.92	Carbon steel with aluminium handle, stainless ball and ring.: L-Handle - Industrial - Steel Part Number: BLP-111-0508-LI-C
11.11 x 63.50 mm (0.44 x 2.50 in.)				
11.11	63.50	9.65	12.92	17-4 PH Stainless: T-Handle - Industrial - Stainless Steel Part Number: BLP-111-0635-TI-S17
11.11	63.50	9.65	12.92	17-4 PH Stainless / Aluminium Handle: Button Handle - Stainless Steel Part Number: BLP-111-0635-BT-S17
11.11	63.50	9.65	12.92	Alloy Steel / Aluminium Handle: T-Handle - Industrial - Steel and Aluminium Part Number: BLP-111-0635-TI-AC
11.11	63.50	9.65	12.92	Carbon Steel: Ring Handle - Industrial - Steel Part Number: BLP-111-0635-RHI-C
11.11	63.50	9.65	12.92	Carbon steel with aluminium handle, stainless ball and ring.: L-Handle - Industrial - Steel Part Number: BLP-111-0635-LI-C



 Usually stocked or Short Delivery
 ** Available while stocks last **

 Long Delivery or Large Minimum Quantities
 Not in current production

Ball Lock Pins

Nominal Pin Dia. A (mm)	Grip Length (mm)	End Distance C (mm)	Open Ball Distance B (mm)	
11.11 x 76.20 mm (0.44 x 3.00 in.)				
11.11	76.20	9.65	12.92	17-4 PH Stainless: T-Handle - Industrial - Stainless Steel Part Number: BLP-111-0762-TI-S17
11.11	76.20	9.65	12.92	Alloy Steel / Aluminium Handle: T-Handle - Industrial - Steel and Aluminium Part Number: BLP-111-0762-TI-AC
11.11	76.20	9.65	12.92	Carbon Steel: Ring Handle - Industrial - Steel Part Number: BLP-111-0762-RHI-C
11.11	76.20	9.65	12.92	Carbon steel with aluminium handle, stainless ball and ring.: L-Handle - Industrial - Steel Part Number: BLP-111-0762-LI-C
11.11 x 88.90 mm (0.44 x 3.50 in.)				
11.11	88.90	9.65	12.93	17-4 PH Stainless: L-Handle - Industrial - Stainless Steel Part Number: BLP-111-0889-LI-S17
11.11 x 101.60 mm (0.44 x 4.00 in.)				
11.11	101.60	9.65	12.92	Alloy Steel / Aluminium Handle: T-Handle - Industrial - Steel and Aluminium Part Number: BLP-111-1016-TI-AC
11.11	101.60	9.65	12.92	Carbon Steel: Ring Handle - Industrial - Steel Part Number: BLP-111-1016-RHI-C
11.11	101.60	9.65	12.92	Carbon steel with aluminium handle, stainless ball and ring.: L-Handle - Industrial - Steel Part Number: BLP-111-1016-LI-C
11.11 x 114.30 mm (0.44 x 4.50 in.)				
11.11	114.30	9.65	12.92	17-4 PH Stainless: Ring Handle - Industrial - Stainless Steel Part Number: BLP-111-1143-RHI-S17
12.00 x 30.00 mm (0.47 x 1.18 in.)				
12.00	30.00	10.00	14.45	Alloy Steel / Aluminium Handle: T-Handle - Industrial - Steel and Aluminium Part Number: BLP-120-0300-TI-AC
12.00 x 40.00 mm (0.47 x 1.57 in.)				
12.00	40.00	10.00	14.45	Alloy Steel / Aluminium Handle: T-Handle - Industrial - Steel and Aluminium Part Number: BLP-120-0400-TI-AC
12.00 x 50.00 mm (0.47 x 1.97 in.)				
12.00	50.00	10.00	14.45	17-4 PH Stainless / Aluminium Handle: T-Handle - Industrial - Stainless Steel and Aluminium Part Number: BLP-120-0500-TI-S17
12.00	50.00	10.00	14.45	Alloy Steel / Aluminium Handle: T-Handle - Industrial - Steel and Aluminium Part Number: BLP-120-0500-TI-AC
12.00 x 75.00 mm (0.47 x 2.95 in.)				
12.00	75.00	10.00	14.45	17-4 PH Stainless / Aluminium Handle: T-Handle - Industrial - Stainless Steel and Aluminium Part Number: BLP-120-0750-TI-S17
12.00 x 80.00 mm (0.47 x 3.15 in.)				
12.00	80.00	10.00	14.45	Alloy Steel / Aluminium Handle: T-Handle - Industrial - Steel and Aluminium Part Number: BLP-120-0800-TI-AC
12.00 x 100.00 mm (0.47 x 3.94 in.)				
12.00	100.00	10.00	14.45	17-4 PH Stainless / Aluminium Handle: T-Handle - Industrial - Stainless Steel and Aluminium Part Number: BLP-120-1000-TI-S17
12.00	100.00	10.00	14.45	Alloy Steel / Aluminium Handle: T-Handle - Industrial - Steel and Aluminium Part Number: BLP-120-1000-TI-AC
12.70 x 12.70 mm (0.50 x 0.50 in.)				
12.70	12.70	11.68	15.09	304 Stainless Steel: T-Handle - Commercial - 304 Stainless Steel Part Number: BLP-127-0127-T-S4
12.70	12.70	11.68	15.09	304 Stainless Steel Shank / Aluminium Handle: Button Handle - Commercial - 304 Stainless Part Number: BLP-127-0127-BT-S4
12.70	12.70	11.68	15.09	Carbon Steel: Button Handle - Commercial - Carbon Steel Part Number: BLP-127-0127-BTC-C
12.70	12.70	11.68	15.09	Carbon Steel: T-Handle - Commercial - Carbon Steel Part Number: BLP-127-0127-TC-C
12.70	12.70	13.18	15.06	Carbon Steel: Shackle Part Number: BLP-127-0127-SHK-C
12.70	12.70	13.46	15.06	17-4 PH Stainless: T-Handle - Stainless Steel - Heavy Duty Part Number: BLP-127-0127-THD-S17

 Usually stocked or Short Delivery
 ** Available while stocks last **

 Long Delivery or Large Minimum Quantities
 Not in current production

Ball Lock Pins



Nominal Pin Dia. A (mm)	Grip Length (mm)	End Distance C (mm)	Open Ball Distance B (mm)	
12.70 x 12.70 mm (0.50 x 0.50 in.)				
12.70	12.70	13.46	15.06	304 Stainless Steel: Marine Style - Half Ring Part Number: BLP-127-0127-MHR-S4
12.70	12.70	13.46	15.06	304 Stainless Steel: Marine Style - Recessed Head Part Number: BLP-127-0127-MRE-S4
12.70	12.70	15.88	14.48	304 Stainless Steel: Keyring Style - 300 Grade Stainless Steel - Dual Ball Part Number: BLP-127-0127-K2-S4
12.70	12.70	15.88	14.48	316 Stainless Steel: Keyring Style - 316 Stainless Steel Part Number: BLP-127-0127-K1-S6
12.70 x 19.05 mm (0.50 x 0.75 in.)				
12.70	19.05	13.46	15.06	304 Stainless Steel: Marine Style - Half Ring Part Number: BLP-127-0191-MHR-S4
12.70	19.05	13.46	15.06	304 Stainless Steel: Marine Style - Recessed Head Part Number: BLP-127-0191-MRE-S4
12.70	19.05	15.88	14.48	304 Stainless Steel: Keyring Style - 300 Grade Stainless Steel - Dual Ball Part Number: BLP-127-0191-K2-S4
12.70	19.05	15.88	14.48	316 Stainless Steel: Keyring Style - 316 Stainless Steel Part Number: BLP-127-0191-K1-S6
12.70 x 25.40 mm (0.50 x 1.00 in.)				
12.70	25.40	11.68	15.08	17-4 PH Stainless: Ring Handle - Industrial - Stainless Steel Part Number: BLP-127-0254-RHI-S17
12.70	25.40	11.68	15.08	17-4 PH Stainless: T-Handle - Industrial - Stainless Steel Part Number: BLP-127-0254-TI-S17
12.70	25.40	11.68	15.08	17-4 PH Stainless / Aluminium Handle: Button Handle - Stainless Steel Part Number: BLP-127-0254-BT-S17
12.70	25.40	11.68	15.08	Alloy Steel / Aluminium Handle: T-Handle - Industrial - Steel and Aluminium Part Number: BLP-127-0254-TI-AC
12.70	25.40	11.68	15.08	Carbon Steel: Button Handle - Steel Part Number: BLP-127-0254-BT-C
12.70	25.40	11.68	15.08	Carbon Steel: Ring Handle - Industrial - Steel Part Number: BLP-127-0254-RHI-C
12.70	25.40	11.68	15.09	17-4 PH or PH15-7MO shank with CRES440C spindle: High Tension - Industrial Part Number: BLP-127-0254-HTI-S17
12.70	25.40	11.68	15.09	17-4 PH Stainless: L-Handle - Industrial - Stainless Steel Part Number: BLP-127-0254-LI-S17
12.70	25.40	11.68	15.09	304 Stainless Steel: T-Handle - Commercial - 304 Stainless Steel Part Number: BLP-127-0254-T-S4
12.70	25.40	11.68	15.09	304 Stainless Steel Shank / Aluminium Handle: Button Handle - Commercial - 304 Stainless Part Number: BLP-127-0254-BT-S4
12.70	25.40	11.68	15.09	Carbon Steel: Button Handle - Commercial - Carbon Steel Part Number: BLP-127-0254-BTC-C
12.70	25.40	11.68	15.09	Carbon Steel: T-Handle - Commercial - Carbon Steel Part Number: BLP-127-0254-TC-C
12.70	25.40	13.46	15.06	17-4 PH Stainless: T-Handle - Stainless Steel - Heavy Duty Part Number: BLP-127-0254-THD-S17
12.70	25.40	13.46	15.06	304 Stainless Steel: Marine Style - Half Ring Part Number: BLP-127-0254-MHR-S4
12.70	25.40	13.46	15.06	304 Stainless Steel: Marine Style - Recessed Head Part Number: BLP-127-0254-MRE-S4
12.70	25.40	15.88	14.48	303 Stainless Steel: Keyring Style - 300 Grade Stainless Steel - Single Ball Part Number: BLP-127-0254-K1-S3
12.70	25.40	15.88	14.48	304 Stainless Steel: Keyring Style - 300 Grade Stainless Steel - Dual Ball Part Number: BLP-127-0254-K2-S4
12.70	25.40	15.88	14.48	316 Stainless Steel: Keyring Style - 316 Stainless Steel Part Number: BLP-127-0254-K1-S6
12.70	25.40	15.88	14.48	Carbon Steel: Keyring Style - Steel Part Number: BLP-127-0254-K1-C
12.70	25.40	15.88	14.48	Carbon Steel: Shoulder Type - Ring Handle Part Number: BLP-127-0254-RSH-C
12.70	25.40	15.88	14.48	Carbon Steel: Shoulder Type - T Handle Part Number: BLP-127-0254-TSH-C



Usually stocked or Short Delivery
** Available while stocks last **

Long Delivery or Large Minimum Quantities
Not in current production

Ball Lock Pins



Nominal Pin Dia. A (mm)	Grip Length (mm)	End Distance C (mm)	Open Ball Distance B (mm)	
12.70 x 31.75 mm (0.50 x 1.25 in.)				
12.70	31.75	11.68	15.08	Alloy Steel / Aluminium Handle: T-Handle - Industrial - Steel and Aluminium Part Number: BLP-127-0318-TI-AC
12.70	31.75	11.68	15.08	Carbon steel with aluminium handle, stainless ball and ring.: L-Handle - Industrial - Steel Part Number: BLP-127-0318-LI-C
12.70	31.75	13.46	15.06	304 Stainless Steel: Marine Style - Half Ring Part Number: BLP-127-0318-MHR-S4
12.70	31.75	13.46	15.06	304 Stainless Steel: Marine Style - Recessed Head Part Number: BLP-127-0318-MRE-S4
12.70	31.75	15.88	14.48	304 Stainless Steel: Keyring Style - 300 Grade Stainless Steel - Dual Ball Part Number: BLP-127-0318-K2-S4
12.70	31.75	15.88	14.48	316 Stainless Steel: Keyring Style - 316 Stainless Steel Part Number: BLP-127-0318-K1-S6
12.70 x 33.02 mm (0.50 x 1.30 in.)				
12.70	33.02	15.88	14.48	303 Stainless Steel: Keyring Style - 300 Grade Stainless Steel - Single Ball Part Number: BLP-127-0330-K1-S3
12.70	33.02	15.88	14.48	Carbon Steel: Keyring Style - Steel Part Number: BLP-127-0330-K1-C
12.70	33.02	15.88	14.48	Carbon Steel: Shoulder Type - Ring Handle Part Number: BLP-127-0330-RSH-C
12.70	33.02	15.88	14.48	Carbon Steel: Shoulder Type - T Handle Part Number: BLP-127-0330-TSH-C
12.70 x 38.10 mm (0.50 x 1.50 in.)				
12.70	38.10	11.68	15.08	17-4 PH Stainless: Ring Handle - Industrial - Stainless Steel Part Number: BLP-127-0381-RHI-S17
12.70	38.10	11.68	15.08	17-4 PH Stainless: T-Handle - Industrial - Stainless Steel Part Number: BLP-127-0381-TI-S17
12.70	38.10	11.68	15.08	17-4 PH Stainless / Aluminium Handle: Button Handle - Stainless Steel Part Number: BLP-127-0381-BT-S17
12.70	38.10	11.68	15.08	Alloy Steel / Aluminium Handle: T-Handle - Industrial - Steel and Aluminium Part Number: BLP-127-0381-TI-AC
12.70	38.10	11.68	15.08	Carbon Steel: Button Handle - Steel Part Number: BLP-127-0381-BT-C
12.70	38.10	11.68	15.08	Carbon Steel: Ring Handle - Industrial - Steel Part Number: BLP-127-0381-RHI-C
12.70	38.10	11.68	15.09	17-4 PH or PH15-7MO shank with CRES440C spindle: High Tension - Industrial Part Number: BLP-127-0381-HTI-S17
12.70	38.10	11.68	15.09	17-4 PH Stainless: Double Acting - T-Handle - Stainless Steel Part Number: BLP-127-0381-DT-S17
12.70	38.10	11.68	15.09	17-4 PH Stainless: L-Handle - Industrial - Stainless Steel Part Number: BLP-127-0381-LI-S17
12.70	38.10	11.68	15.09	304 Stainless Steel: T-Handle - Commercial - 304 Stainless Steel Part Number: BLP-127-0381-T-S4
12.70	38.10	11.68	15.09	304 Stainless Steel Shank / Aluminium Handle: Button Handle - Commercial - 304 Stainless Part Number: BLP-127-0381-BT-S4
12.70	38.10	11.68	15.09	Carbon Steel: Button Handle - Commercial - Carbon Steel Part Number: BLP-127-0381-BTC-C
12.70	38.10	11.68	15.09	Carbon Steel: T-Handle - Commercial - Carbon Steel Part Number: BLP-127-0381-TC-C
12.70	38.10	13.18	15.06	Carbon Steel: Shackle Part Number: BLP-127-0381-SHK-C
12.70	38.10	13.46	15.06	17-4 PH Stainless: T-Handle - Stainless Steel - Heavy Duty Part Number: BLP-127-0381-THD-S17
12.70	38.10	13.46	15.06	304 Stainless Steel: Marine Style - Half Ring Part Number: BLP-127-0381-MHR-S4
12.70	38.10	13.46	15.06	304 Stainless Steel: Marine Style - Recessed Head Part Number: BLP-127-0381-MRE-S4
12.70	38.10	15.88	14.48	303 Stainless Steel: Keyring Style - 300 Grade Stainless Steel - Single Ball Part Number: BLP-127-0381-K1-S3
12.70	38.10	15.88	14.48	304 Stainless Steel: Keyring Style - 300 Grade Stainless Steel - Dual Ball Part Number: BLP-127-0381-K2-S4



 Usually stocked or Short Delivery
 ** Available while stocks last **

 Long Delivery or Large Minimum Quantities
 Not in current production

Ball Lock Pins

Nominal Pin Dia. A (mm)	Grip Length (mm)	End Distance C (mm)	Open Ball Distance B (mm)	
12.70 x 38.10 mm		<i>(0.50 x 1.50 in.)</i>		
12.70	38.10	15.88	14.48	316 Stainless Steel: Keyring Style - 316 Stainless Steel Part Number: BLP-127-0381-K1-S6
12.70	38.10	15.88	14.48	Carbon Steel: Keyring Style - Steel Part Number: BLP-127-0381-K1-C
12.70	38.10	15.88	14.48	Carbon Steel: Shoulder Type - Ring Handle Part Number: BLP-127-0381-RSH-C
12.70	38.10	15.88	14.48	Carbon Steel: Shoulder Type - T Handle Part Number: BLP-127-0381-TSH-C
12.70 x 44.45 mm		<i>(0.50 x 1.75 in.)</i>		
12.70	44.45	11.68	15.08	Alloy Steel / Aluminium Handle: T-Handle - Industrial - Steel and Aluminium Part Number: BLP-127-0445-TI-AC
12.70	44.45	11.68	15.08	Carbon Steel: Ring Handle - Industrial - Steel Part Number: BLP-127-0444-RHI-C
12.70	44.45	11.68	15.08	Carbon steel with aluminium handle, stainless ball and ring.: L-Handle - Industrial - Steel Part Number: BLP-127-0445-LI-C
12.70	44.45	13.46	15.06	304 Stainless Steel: Marine Style - Half Ring Part Number: BLP-127-0445-MHR-S4
12.70	44.45	13.46	15.06	304 Stainless Steel: Marine Style - Recessed Head Part Number: BLP-127-0445-MRE-S4
12.70	44.45	15.88	14.48	304 Stainless Steel: Keyring Style - 300 Grade Stainless Steel - Dual Ball Part Number: BLP-127-0445-K2-S4
12.70	44.45	15.88	14.48	316 Stainless Steel: Keyring Style - 316 Stainless Steel Part Number: BLP-127-0445-K1-S6
12.70 x 50.80 mm		<i>(0.50 x 2.00 in.)</i>		
12.70	50.80	11.68	15.08	17-4 PH Stainless: Ring Handle - Industrial - Stainless Steel Part Number: BLP-127-0508-RHI-S17
12.70	50.80	11.68	15.08	17-4 PH Stainless: T-Handle - Industrial - Stainless Steel Part Number: BLP-127-0508-TI-S17
12.70	50.80	11.68	15.08	17-4 PH Stainless / Aluminium Handle: Button Handle - Stainless Steel Part Number: BLP-127-0508-BT-S17
12.70	50.80	11.68	15.08	Alloy Steel / Aluminium Handle: T-Handle - Industrial - Steel and Aluminium Part Number: BLP-127-0508-TI-AC
12.70	50.80	11.68	15.08	Carbon Steel: Button Handle - Steel Part Number: BLP-127-0508-BT-C
12.70	50.80	11.68	15.08	Carbon Steel: Ring Handle - Industrial - Steel Part Number: BLP-127-0508-RHI-C
12.70	50.80	11.68	15.09	17-4 PH or PH15-7MO shank with CRES440C spindle: High Tension - Industrial Part Number: BLP-127-0508-HTI-S17
12.70	50.80	11.68	15.09	17-4 PH Stainless: Double Acting - Ring Handle - Stainless Steel Part Number: BLP-127-0508-DR-S17
12.70	50.80	11.68	15.09	17-4 PH Stainless: Double Acting - T-Handle - Stainless Steel Part Number: BLP-127-0508-DT-S17
12.70	50.80	11.68	15.09	17-4 PH Stainless: L-Handle - Industrial - Stainless Steel Part Number: BLP-127-0508-LI-S17
12.70	50.80	11.68	15.09	304 Stainless Steel: T-Handle - Commercial - 304 Stainless Steel Part Number: BLP-127-0508-T-S4
12.70	50.80	11.68	15.09	304 Stainless Steel Shank / Aluminium Handle: Button Handle - Commercial - 304 Stainless Part Number: BLP-127-0508-BT-S4
12.70	50.80	11.68	15.09	Carbon Steel: Button Handle - Commercial - Carbon Steel Part Number: BLP-127-0508-BTC-C
12.70	50.80	11.68	15.09	Carbon Steel: T-Handle - Commercial - Carbon Steel Part Number: BLP-127-0508-TC-C
12.70	50.80	13.46	15.06	17-4 PH Stainless: T-Handle - Stainless Steel - Heavy Duty Part Number: BLP-127-0508-THD-S17
12.70	50.80	13.46	15.06	304 Stainless Steel: Marine Style - Half Ring Part Number: BLP-127-0508-MHR-S4
12.70	50.80	13.46	15.06	304 Stainless Steel: Marine Style - Recessed Head Part Number: BLP-127-0508-MRE-S4
12.70	50.80	15.88	14.48	303 Stainless Steel: Keyring Style - 300 Grade Stainless Steel - Single Ball Part Number: BLP-127-0508-K1-S3

 Usually stocked or Short Delivery
 ** Available while stocks last **

 Long Delivery or Large Minimum Quantities
 Not in current production

Ball Lock Pins



Nominal Pin Dia. A (mm)	Grip Length (mm)	End Distance C (mm)	Open Ball Distance B (mm)	
12.70 x 50.80 mm (0.50 x 2.00 in.)				
12.70	50.80	15.88	14.48	304 Stainless Steel: Keyring Style - 300 Grade Stainless Steel - Dual Ball Part Number: BLP-127-0508-K2-S4
12.70	50.80	15.88	14.48	316 Stainless Steel: Keyring Style - 316 Stainless Steel Part Number: BLP-127-0508-K1-S6
12.70	50.80	15.88	14.48	Carbon Steel: Keyring Style - Steel Part Number: BLP-127-0508-K1-C
12.70	50.80	15.88	14.48	Carbon Steel: Shoulder Type - Ring Handle Part Number: BLP-127-0508-RSH-C
12.70	50.80	15.88	14.48	Carbon Steel: Shoulder Type - T Handle Part Number: BLP-127-0508-TSH-C
12.70 x 57.15 mm (0.50 x 2.25 in.)				
12.70	57.15	13.46	15.06	304 Stainless Steel: Marine Style - Half Ring Part Number: BLP-127-0572-MHR-S4
12.70	57.15	13.46	15.06	304 Stainless Steel: Marine Style - Recessed Head Part Number: BLP-127-0572-MRE-S4
12.70	57.15	15.88	14.48	304 Stainless Steel: Keyring Style - 300 Grade Stainless Steel - Dual Ball Part Number: BLP-127-0572-K2-S4
12.70	57.15	15.88	14.48	316 Stainless Steel: Keyring Style - 316 Stainless Steel Part Number: BLP-127-0572-K1-S6
12.70 x 58.42 mm (0.50 x 2.30 in.)				
12.70	58.42	15.88	14.48	Carbon Steel: Shoulder Type - Ring Handle Part Number: BLP-127-0584-RSH-C
12.70	58.42	15.88	14.48	Carbon Steel: Shoulder Type - T Handle Part Number: BLP-127-0584-TSH-C
12.70 x 63.50 mm (0.50 x 2.50 in.)				
12.70	63.50	11.68	15.08	17-4 PH Stainless: T-Handle - Industrial - Stainless Steel Part Number: BLP-127-0635-TI-S17
12.70	63.50	11.68	15.08	17-4 PH Stainless / Aluminium Handle: Button Handle - Stainless Steel Part Number: BLP-127-0635-BT-S17
12.70	63.50	11.68	15.08	Alloy Steel / Aluminium Handle: T-Handle - Industrial - Steel and Aluminium Part Number: BLP-127-0635-TI-AC
12.70	63.50	11.68	15.08	Carbon Steel: Button Handle - Steel Part Number: BLP-127-0635-BT-C
12.70	63.50	11.68	15.08	Carbon Steel: Ring Handle - Industrial - Steel Part Number: BLP-127-0635-RHI-C
12.70	63.50	11.68	15.08	Carbon steel with aluminium handle, stainless ball and ring.: L-Handle - Industrial - Steel Part Number: BLP-127-0635-LI-C
12.70	63.50	11.68	15.09	17-4 PH or PH15-7MO shank with CRES440C spindle: High Tension - Industrial Part Number: BLP-127-0635-HTI-S17
12.70	63.50	11.68	15.09	17-4 PH Stainless: Double Acting - Ring Handle - Stainless Steel Part Number: BLP-127-0635-DR-S17
12.70	63.50	11.68	15.09	17-4 PH Stainless: Double Acting - T-Handle - Stainless Steel Part Number: BLP-127-0635-DT-S17
12.70	63.50	11.68	15.09	17-4 PH Stainless: L-Handle - Industrial - Stainless Steel Part Number: BLP-127-0635-LI-S17
12.70	63.50	11.68	15.09	304 Stainless Steel: T-Handle - Commercial - 304 Stainless Steel Part Number: BLP-127-0635-T-S4
12.70	63.50	11.68	15.09	304 Stainless Steel Shank / Aluminium Handle: Button Handle - Commercial - 304 Stainless Part Number: BLP-127-0635-BT-S4
12.70	63.50	11.68	15.09	Carbon Steel: Button Handle - Commercial - Carbon Steel Part Number: BLP-127-0635-BTC-C
12.70	63.50	11.68	15.09	Carbon Steel: T-Handle - Commercial - Carbon Steel Part Number: BLP-127-0635-TC-C
12.70	63.50	13.46	15.06	17-4 PH Stainless: T-Handle - Stainless Steel - Heavy Duty Part Number: BLP-127-0635-THD-S17
12.70	63.50	13.46	15.06	304 Stainless Steel: Marine Style - Half Ring Part Number: BLP-127-0635-MHR-S4
12.70	63.50	13.46	15.06	304 Stainless Steel: Marine Style - Recessed Head Part Number: BLP-127-0635-MRE-S4
12.70	63.50	15.88	14.48	303 Stainless Steel: Keyring Style - 300 Grade Stainless Steel - Single Ball Part Number: BLP-127-0635-K1-S3



Usually stocked or Short Delivery
** Available while stocks last **

Long Delivery or Large Minimum Quantities
Not in current production

Ball Lock Pins



Nominal Pin Dia. A (mm)	Grip Length (mm)	End Distance C (mm)	Open Ball Distance B (mm)	
12.70 x 63.50 mm (0.50 x 2.50 in.)				
12.70	63.50	15.88	14.48	304 Stainless Steel: Keyring Style - 300 Grade Stainless Steel - Dual Ball Part Number: BLP-127-0635-K2-S4
12.70	63.50	15.88	14.48	316 Stainless Steel: Keyring Style - 316 Stainless Steel Part Number: BLP-127-0635-K1-S6
12.70	63.50	15.88	14.48	Carbon Steel: Keyring Style - Steel Part Number: BLP-127-0635-K1-C
12.70	63.50	15.88	14.48	Carbon Steel: Shoulder Type - Ring Handle Part Number: BLP-127-0635-RSH-C
12.70	63.50	15.88	14.48	Carbon Steel: Shoulder Type - T Handle Part Number: BLP-127-0635-TSH-C
12.70 x 69.85 mm (0.50 x 2.75 in.)				
12.70	69.85	13.46	15.06	304 Stainless Steel: Marine Style - Half Ring Part Number: BLP-127-0699-MHR-S4
12.70	69.85	13.46	15.06	304 Stainless Steel: Marine Style - Recessed Head Part Number: BLP-127-0699-MRE-S4
12.70	69.85	15.88	14.48	304 Stainless Steel: Keyring Style - 300 Grade Stainless Steel - Dual Ball Part Number: BLP-127-0699-K2-S4
12.70	69.85	15.88	14.48	316 Stainless Steel: Keyring Style - 316 Stainless Steel Part Number: BLP-127-0699-K1-S6
12.70 x 76.20 mm (0.50 x 3.00 in.)				
12.70	76.20	11.68	15.08	17-4 PH Stainless: Ring Handle - Industrial - Stainless Steel Part Number: BLP-127-0762-RHI-S17
12.70	76.20	11.68	15.08	17-4 PH Stainless: T-Handle - Industrial - Stainless Steel Part Number: BLP-127-0762-TI-S17
12.70	76.20	11.68	15.08	17-4 PH Stainless / Aluminium Handle: Button Handle - Stainless Steel Part Number: BLP-127-0762-BT-S17
12.70	76.20	11.68	15.08	Alloy Steel / Aluminium Handle: T-Handle - Industrial - Steel and Aluminium Part Number: BLP-127-0762-TI-AC
12.70	76.20	11.68	15.08	Carbon Steel: Button Handle - Steel Part Number: BLP-127-0760-BT-C
12.70	76.20	11.68	15.08	Carbon Steel: Ring Handle - Industrial - Steel Part Number: BLP-127-0762-RHI-C
12.70	76.20	11.68	15.08	Carbon steel with aluminium handle, stainless ball and ring.: L-Handle - Industrial - Steel Part Number: BLP-127-0762-LI-C
12.70	76.20	11.68	15.09	17-4 PH or PH15-7MO shank with CRES440C spindle: High Tension - Industrial Part Number: BLP-127-0762-HTI-S17
12.70	76.20	11.68	15.09	17-4 PH Stainless: Double Acting - L-Handle - Stainless Steel Part Number: BLP-127-0762-DL-S17
12.70	76.20	11.68	15.09	17-4 PH Stainless: Double Acting - Ring Handle - Stainless Steel Part Number: BLP-127-0762-DR-S17
12.70	76.20	11.68	15.09	17-4 PH Stainless: Double Acting - T-Handle - Stainless Steel Part Number: BLP-127-0762-DT-S17
12.70	76.20	11.68	15.09	17-4 PH Stainless: L-Handle - Industrial - Stainless Steel Part Number: BLP-127-0762-LI-S17
12.70	76.20	11.68	15.09	304 Stainless Steel: T-Handle - Commercial - 304 Stainless Steel Part Number: BLP-127-0762-T-S4
12.70	76.20	11.68	15.09	304 Stainless Steel Shank / Aluminium Handle: Button Handle - Commercial - 304 Stainless Part Number: BLP-127-0762-BT-S4
12.70	76.20	11.68	15.09	Carbon Steel: Button Handle - Commercial - Carbon Steel Part Number: BLP-127-0762-BTC-C
12.70	76.20	11.68	15.09	Carbon Steel: T-Handle - Commercial - Carbon Steel Part Number: BLP-127-0762-TC-C
12.70	76.20	13.46	15.06	17-4 PH Stainless: T-Handle - Stainless Steel - Heavy Duty Part Number: BLP-127-0762-THD-S17
12.70	76.20	13.46	15.06	304 Stainless Steel: Marine Style - Half Ring Part Number: BLP-127-0762-MHR-S4
12.70	76.20	15.88	14.48	303 Stainless Steel: Keyring Style - 300 Grade Stainless Steel - Single Ball Part Number: BLP-127-0762-K1-S3
12.70	76.20	15.88	14.48	304 Stainless Steel: Keyring Style - 300 Grade Stainless Steel - Dual Ball Part Number: BLP-127-0762-K2-S4



 Usually stocked or Short Delivery
 ** Available while stocks last **

 Long Delivery or Large Minimum Quantities
 Not in current production

Ball Lock Pins



Nominal Pin Dia. A (mm)	Grip Length (mm)	End Distance C (mm)	Open Ball Distance B (mm)	
12.70 x 76.20 mm (0.50 x 3.00 in.)				
12.70	76.20	15.88	14.48	316 Stainless Steel: Keyring Style - 316 Stainless Steel Part Number: BLP-127-0762-K1-S6
12.70	76.20	15.88	14.48	Carbon Steel: Keyring Style - Steel Part Number: BLP-127-0762-K1-C
12.70	76.20	15.88	14.48	Carbon Steel: Shoulder Type - Ring Handle Part Number: BLP-127-0762-RSH-C
12.70	76.20	15.88	14.48	Carbon Steel: Shoulder Type - T Handle Part Number: BLP-127-0762-TSH-C
12.70 x 82.55 mm (0.50 x 3.25 in.)				
12.70	82.55	13.46	15.06	304 Stainless Steel: Marine Style - Half Ring Part Number: BLP-127-0826-MHR-S4
12.70	82.55	13.46	15.06	304 Stainless Steel: Marine Style - Recessed Head Part Number: BLP-127-0826-MRE-S4
12.70	82.55	15.88	14.48	304 Stainless Steel: Keyring Style - 300 Grade Stainless Steel - Dual Ball Part Number: BLP-127-0826-K2-S4
12.70	82.55	15.88	14.48	316 Stainless Steel: Keyring Style - 316 Stainless Steel Part Number: BLP-127-0826-K1-S6
12.70 x 88.90 mm (0.50 x 3.50 in.)				
12.70	88.90	11.68	15.08	17-4 PH Stainless: T-Handle - Industrial - Stainless Steel Part Number: BLP-127-0889-TI-S17
12.70	88.90	11.68	15.08	17-4 PH Stainless / Aluminium Handle: Button Handle - Stainless Steel Part Number: BLP-127-0889-BT-S17
12.70	88.90	11.68	15.08	Alloy Steel / Aluminium Handle: T-Handle - Industrial - Steel and Aluminium Part Number: BLP-127-0889-TI-AC
12.70	88.90	11.68	15.08	Carbon Steel: Button Handle - Steel Part Number: BLP-127-0889-BT-C
12.70	88.90	11.68	15.08	Carbon Steel: Ring Handle - Industrial - Steel Part Number: BLP-127-0889-RHI-C
12.70	88.90	11.68	15.08	Carbon steel with aluminium handle, stainless ball and ring.: L-Handle - Industrial - Steel Part Number: BLP-127-0889-LI-C
12.70	88.90	11.68	15.09	17-4 PH Stainless: L-Handle - Industrial - Stainless Steel Part Number: BLP-127-0889-LI-S17
12.70	88.90	11.68	15.09	304 Stainless Steel: T-Handle - Commercial - 304 Stainless Steel Part Number: BLP-127-0889-T-S4
12.70	88.90	11.68	15.09	304 Stainless Steel Shank / Aluminium Handle: Button Handle - Commercial - 304 Stainless Part Number: BLP-127-0889-BT-S4
12.70	88.90	11.68	15.09	Carbon Steel: Button Handle - Commercial - Carbon Steel Part Number: BLP-127-0889-BTC-C
12.70	88.90	11.68	15.09	Carbon Steel: T-Handle - Commercial - Carbon Steel Part Number: BLP-127-0889-TC-C
12.70	88.90	13.46	15.06	17-4 PH Stainless: T-Handle - Stainless Steel - Heavy Duty Part Number: BLP-127-0889-THD-S17
12.70	88.90	13.46	15.06	304 Stainless Steel: Marine Style - Half Ring Part Number: BLP-127-0889-MHR-S4
12.70	88.90	13.46	15.06	304 Stainless Steel: Marine Style - Recessed Head Part Number: BLP-127-0889-MRE-S4
12.70	88.90	15.88	14.48	303 Stainless Steel: Keyring Style - 300 Grade Stainless Steel - Single Ball Part Number: BLP-127-0889-K1-S3
12.70	88.90	15.88	14.48	304 Stainless Steel: Keyring Style - 300 Grade Stainless Steel - Dual Ball Part Number: BLP-127-0889-K2-S4
12.70	88.90	15.88	14.48	316 Stainless Steel: Keyring Style - 316 Stainless Steel Part Number: BLP-127-0889-K1-S6
12.70	88.90	15.88	14.48	Carbon Steel: Keyring Style - Steel Part Number: BLP-127-0889-K1-C
12.70	88.90	15.88	14.48	Carbon Steel: Shoulder Type - T Handle Part Number: BLP-127-0889-TSH-C
12.70 x 95.25 mm (0.50 x 3.75 in.)				
12.70	95.25	13.46	15.06	304 Stainless Steel: Marine Style - Half Ring Part Number: BLP-127-0953-MHR-S4
12.70	95.25	13.46	15.06	304 Stainless Steel: Marine Style - Recessed Head Part Number: BLP-127-0953-MRE-S4



 Usually stocked or Short Delivery
 ** Available while stocks last **

 Long Delivery or Large Minimum Quantities
 Not in current production

Ball Lock Pins

Nominal Pin Dia. A (mm)	Grip Length (mm)	End Distance C (mm)	Open Ball Distance B (mm)	
12.70 x 95.25 mm (0.50 x 3.75 in.)				
12.70	95.25	15.88	14.48	304 Stainless Steel: Keyring Style - 300 Grade Stainless Steel - Dual Ball Part Number: BLP-127-0953-K2-S4
12.70	95.25	15.88	14.48	316 Stainless Steel: Keyring Style - 316 Stainless Steel Part Number: BLP-127-0953-K1-S6
12.70 x 101.60 mm (0.50 x 4.00 in.)				
12.70	101.60	11.68	15.08	17-4 PH Stainless: Ring Handle - Industrial - Stainless Steel Part Number: BLP-127-1016-RHI-S17
12.70	101.60	11.68	15.08	17-4 PH Stainless: T-Handle - Industrial - Stainless Steel Part Number: BLP-127-1016-TI-S17
12.70	101.60	11.68	15.08	17-4 PH Stainless / Aluminium Handle: Button Handle - Stainless Steel Part Number: BLP-127-1016-BT-S17
12.70	101.60	11.68	15.08	Alloy Steel / Aluminium Handle: T-Handle - Industrial - Steel and Aluminium Part Number: BLP-127-1016-TI-AC
12.70	101.60	11.68	15.08	Carbon Steel: Button Handle - Steel Part Number: BLP-127-1016-BT-C
12.70	101.60	11.68	15.08	Carbon Steel: Ring Handle - Industrial - Steel Part Number: BLP-127-1016-RHI-C
12.70	101.60	11.68	15.08	Carbon steel with aluminium handle, stainless ball and ring.: L-Handle - Industrial - Steel Part Number: BLP-127-1016-LI-C
12.70	101.60	11.68	15.09	17-4 PH or PH15-7MO shank with CRES440C spindle: High Tension - Industrial Part Number: BLP-127-1016-HTI-S17
12.70	101.60	11.68	15.09	17-4 PH Stainless: L-Handle - Industrial - Stainless Steel Part Number: BLP-127-1016-LI-S17
12.70	101.60	11.68	15.09	304 Stainless Steel: T-Handle - Commercial - 304 Stainless Steel Part Number: BLP-127-1016-T-S4
12.70	101.60	11.68	15.09	304 Stainless Steel Shank / Aluminium Handle: Button Handle - Commercial - 304 Stainless Part Number: BLP-127-1016-BT-S4
12.70	101.60	11.68	15.09	Carbon Steel: Button Handle - Commercial - Carbon Steel Part Number: BLP-127-1016-BTC-C
12.70	101.60	11.68	15.09	Carbon Steel: T-Handle - Commercial - Carbon Steel Part Number: BLP-127-1016-TC-C
12.70	101.60	13.46	15.06	17-4 PH Stainless: T-Handle - Stainless Steel - Heavy Duty Part Number: BLP-127-1016-THD-S17
12.70	101.60	13.46	15.06	304 Stainless Steel: Marine Style - Half Ring Part Number: BLP-127-1016-MHR-S4
12.70	101.60	13.46	15.06	304 Stainless Steel: Marine Style - Recessed Head Part Number: BLP-127-1016-MRE-S4
12.70	101.60	15.88	14.48	303 Stainless Steel: Keyring Style - 300 Grade Stainless Steel - Single Ball Part Number: BLP-127-1016-K1-S3
12.70	101.60	15.88	14.48	304 Stainless Steel: Keyring Style - 300 Grade Stainless Steel - Dual Ball Part Number: BLP-127-1016-K2-S4
12.70	101.60	15.88	14.48	316 Stainless Steel: Keyring Style - 316 Stainless Steel Part Number: BLP-127-1016-K1-S6
12.70	101.60	15.88	14.48	Carbon Steel: Keyring Style - Steel Part Number: BLP-127-1016-K1-C
12.70	101.60	15.88	14.48	Carbon Steel: Shoulder Type - Ring Handle Part Number: BLP-127-1016-RSH-C
12.70	101.60	15.88	14.48	Carbon Steel: Shoulder Type - T Handle Part Number: BLP-127-1016-TSH-C
12.70 x 107.95 mm (0.50 x 4.25 in.)				
12.70	107.95	13.46	15.06	304 Stainless Steel: Marine Style - Half Ring Part Number: BLP-127-1080-MHR-S4
12.70	107.95	13.46	15.06	304 Stainless Steel: Marine Style - Recessed Head Part Number: BLP-127-1080-MRE-S4
12.70	107.95	15.88	14.48	304 Stainless Steel: Keyring Style - 300 Grade Stainless Steel - Dual Ball Part Number: BLP-127-1080-K2-S4
12.70	107.95	15.88	14.48	316 Stainless Steel: Keyring Style - 316 Stainless Steel Part Number: BLP-127-1080-K1-S6
12.70 x 114.30 mm (0.50 x 4.50 in.)				
12.70	114.30	11.68	15.08	17-4 PH Stainless: Ring Handle - Industrial - Stainless Steel Part Number: BLP-127-1143-RHI-S17

 Usually stocked or Short Delivery
 ** Available while stocks last **

 Long Delivery or Large Minimum Quantities
 Not in current production

Ball Lock Pins



Nominal Pin Dia. A (mm)	Grip Length (mm)	End Distance C (mm)	Open Ball Distance B (mm)	
12.70 x 114.30 mm (0.50 x 4.50 in.)				
12.70	114.30	11.68	15.08	17-4 PH Stainless: T-Handle - Industrial - Stainless Steel Part Number: BLP-127-1143-TI-S17
12.70	114.30	11.68	15.08	Alloy Steel / Aluminium Handle: T-Handle - Industrial - Steel and Aluminium Part Number: BLP-127-1143-TI-AC
12.70	114.30	11.68	15.08	Carbon Steel: Button Handle - Steel Part Number: BLP-127-1143-BT-C
12.70	114.30	11.68	15.08	Carbon Steel: Ring Handle - Industrial - Steel Part Number: BLP-127-1143-RHI-C
12.70	114.30	11.68	15.08	Carbon steel with aluminium handle, stainless ball and ring.: L-Handle - Industrial - Steel Part Number: BLP-127-1143-LI-C
12.70	114.30	11.68	15.09	17-4 PH Stainless: Double Acting - Ring Handle - Stainless Steel Part Number: BLP-127-1143-DR-S17
12.70	114.30	11.68	15.09	17-4 PH Stainless: L-Handle - Industrial - Stainless Steel Part Number: BLP-127-1143-LI-S17
12.70	114.30	13.46	15.06	17-4 PH Stainless: T-Handle - Stainless Steel - Heavy Duty Part Number: BLP-127-1143-THD-S17
12.70	114.30	13.46	15.06	304 Stainless Steel: Marine Style - Half Ring Part Number: BLP-127-1143-MHR-S4
12.70	114.30	13.46	15.06	304 Stainless Steel: Marine Style - Recessed Head Part Number: BLP-127-1143-MRE-S4
12.70	114.30	15.88	14.48	304 Stainless Steel: Keyring Style - 300 Grade Stainless Steel - Dual Ball Part Number: BLP-127-1143-K2-S4
12.70	114.30	15.88	14.48	316 Stainless Steel: Keyring Style - 316 Stainless Steel Part Number: BLP-127-1143-K1-S6
12.70	114.30	15.88	14.48	Carbon Steel: Keyring Style - Steel Part Number: BLP-127-1143-K1-C
12.70 x 120.65 mm (0.50 x 4.75 in.)				
12.70	120.65	13.46	15.06	304 Stainless Steel: Marine Style - Half Ring Part Number: BLP-127-1207-MHR-S4
12.70	120.65	13.46	15.06	304 Stainless Steel: Marine Style - Recessed Head Part Number: BLP-127-1207-MRE-S4
12.70	120.65	15.88	14.48	304 Stainless Steel: Keyring Style - 300 Grade Stainless Steel - Dual Ball Part Number: BLP-127-1207-K2-S4
12.70	120.65	15.88	14.48	316 Stainless Steel: Keyring Style - 316 Stainless Steel Part Number: BLP-127-1207-K1-S6
12.70 x 127.00 mm (0.50 x 5.00 in.)				
12.70	127.00	11.68	15.08	17-4 PH Stainless: T-Handle - Industrial - Stainless Steel Part Number: BLP-127-1270-TI-S17
12.70	127.00	11.68	15.08	17-4 PH Stainless / Aluminium Handle: Button Handle - Stainless Steel Part Number: BLP-127-1270-BT-S17
12.70	127.00	11.68	15.08	Alloy Steel / Aluminium Handle: T-Handle - Industrial - Steel and Aluminium Part Number: BLP-127-1270-TI-AC
12.70	127.00	11.68	15.08	Carbon Steel: Button Handle - Steel Part Number: BLP-127-1270-BT-C
12.70	127.00	11.68	15.08	Carbon Steel: Ring Handle - Industrial - Steel Part Number: BLP-127-1270-RHI-C
12.70	127.00	11.68	15.08	Carbon steel with aluminium handle, stainless ball and ring.: L-Handle - Industrial - Steel Part Number: BLP-127-1270-LI-C
12.70	127.00	13.46	15.06	304 Stainless Steel: Marine Style - Half Ring Part Number: BLP-127-1270-MHR-S4
12.70	127.00	13.46	15.06	304 Stainless Steel: Marine Style - Recessed Head Part Number: BLP-127-1270-MRE-S4
12.70	127.00	15.88	14.48	303 Stainless Steel: Keyring Style - 300 Grade Stainless Steel - Single Ball Part Number: BLP-127-1270-K1-S3
12.70	127.00	15.88	14.48	304 Stainless Steel: Keyring Style - 300 Grade Stainless Steel - Dual Ball Part Number: BLP-127-1270-K2-S4
12.70	127.00	15.88	14.48	316 Stainless Steel: Keyring Style - 316 Stainless Steel Part Number: BLP-127-1270-K1-S6
12.70	127.00	15.88	14.48	Carbon Steel: Keyring Style - Steel Part Number: BLP-127-1270-K1-C
12.70	127.00	15.88	14.48	Carbon Steel: Shoulder Type - Ring Handle Part Number: BLP-127-1270-RSH-C



Usually stocked or Short Delivery
** Available while stocks last **

Long Delivery or Large Minimum Quantities
Not in current production

Ball Lock Pins



Nominal Pin Dia. A (mm)	Grip Length (mm)	End Distance C (mm)	Open Ball Distance B (mm)	
12.70 x 127.00 mm (0.50 x 5.00 in.)				
12.70	127.00	15.88	14.48	Carbon Steel: Shoulder Type - T Handle Part Number: BLP-127-1270-TSH-C
12.70 x 139.70 mm (0.50 x 5.50 in.)				
12.70	139.70	11.68	15.08	17-4 PH Stainless: T-Handle - Industrial - Stainless Steel Part Number: BLP-127-1397-TI-S17
12.70	139.70	11.68	15.08	Alloy Steel / Aluminium Handle: T-Handle - Industrial - Steel and Aluminium Part Number: BLP-127-1397-TI-AC
12.70	139.70	11.68	15.08	Carbon Steel: Button Handle - Steel Part Number: BLP-127-1397-BT-C
12.70	139.70	11.68	15.08	Carbon Steel: Ring Handle - Industrial - Steel Part Number: BLP-127-1397-RHI-C
12.70	139.70	11.68	15.08	Carbon steel with aluminium handle, stainless ball and ring.: L-Handle - Industrial - Steel Part Number: BLP-127-1397-LI-C
12.70	139.70	15.88	14.48	303 Stainless Steel: Keyring Style - 300 Grade Stainless Steel - Single Ball Part Number: BLP-127-1397-K1-S3
12.70	139.70	15.88	14.48	Carbon Steel: Keyring Style - Steel Part Number: BLP-127-1397-K1-C
12.70 x 152.40 mm (0.50 x 6.00 in.)				
12.70	152.40	11.68	15.08	17-4 PH Stainless: T-Handle - Industrial - Stainless Steel Part Number: BLP-127-1524-TI-S17
12.70	152.40	11.68	15.08	Alloy Steel / Aluminium Handle: T-Handle - Industrial - Steel and Aluminium Part Number: BLP-127-1524-TI-AC
12.70	152.40	11.68	15.08	Carbon Steel: Ring Handle - Industrial - Steel Part Number: BLP-127-1524-RHI-C
12.70	152.40	11.68	15.08	Carbon steel with aluminium handle, stainless ball and ring.: L-Handle - Industrial - Steel Part Number: BLP-127-1524-LI-C
12.70	152.40	13.46	15.06	304 Stainless Steel: Marine Style - Recessed Head Part Number: BLP-127-1524-MRE-S4
12.70	152.40	15.88	14.48	303 Stainless Steel: Keyring Style - 300 Grade Stainless Steel - Single Ball Part Number: BLP-127-1524-K1-S3
12.70	152.40	15.88	14.48	Carbon Steel: Keyring Style - Steel Part Number: BLP-127-1524-K1-C
14.29 x 50.80 mm (0.56 x 2.00 in.)				
14.29	50.80	12.95	16.91	Alloy Steel / Aluminium Handle: T-Handle - Industrial - Steel and Aluminium Part Number: BLP-143-0508-TI-AC
14.29	50.80	12.95	16.91	Carbon Steel: Ring Handle - Industrial - Steel Part Number: BLP-143-0508-RHI-C
14.29	50.80	12.95	16.91	Carbon steel with aluminium handle, stainless ball and ring.: L-Handle - Industrial - Steel Part Number: BLP-143-0508-LI-C
14.29 x 63.50 mm (0.56 x 2.50 in.)				
14.29	63.50	12.95	16.91	Alloy Steel / Aluminium Handle: T-Handle - Industrial - Steel and Aluminium Part Number: BLP-143-0635-TI-AC
14.29	63.50	12.95	16.91	Carbon steel with aluminium handle, stainless ball and ring.: L-Handle - Industrial - Steel Part Number: BLP-143-0635-LI-C
14.29 x 76.20 mm (0.56 x 3.00 in.)				
14.29	76.20	12.95	16.91	Alloy Steel / Aluminium Handle: T-Handle - Industrial - Steel and Aluminium Part Number: BLP-143-0762-TI-AC
14.29	76.20	12.95	16.91	Carbon Steel: Ring Handle - Industrial - Steel Part Number: BLP-143-0762-RHI-C
14.29 x 88.90 mm (0.56 x 3.50 in.)				
14.29	88.90	12.95	16.91	Alloy Steel / Aluminium Handle: T-Handle - Industrial - Steel and Aluminium Part Number: BLP-143-0889-TI-AC
14.29	88.90	12.95	16.91	Carbon steel with aluminium handle, stainless ball and ring.: L-Handle - Industrial - Steel Part Number: BLP-143-0889-LI-C
14.29 x 101.60 mm (0.56 x 4.00 in.)				
14.29	101.60	12.95	16.91	Alloy Steel / Aluminium Handle: T-Handle - Industrial - Steel and Aluminium Part Number: BLP-143-1016-TI-AC



 Usually stocked or Short Delivery
 ** Available while stocks last **

 Long Delivery or Large Minimum Quantities
 Not in current production

Ball Lock Pins

Nominal Pin Dia. A (mm)	Grip Length (mm)	End Distance C (mm)	Open Ball Distance B (mm)	
15.88 x 5.80 mm (0.63 x 0.23 in.)				
15.88	5.80	14.73	19.05	Alloy Steel / Aluminium Handle: T-Handle - Industrial - Steel and Aluminium Part Number: BLP-159-0058-TI-AC
15.88 x 12.70 mm (0.63 x 0.50 in.)				
15.88	12.70	14.73	19.05	304 Stainless Steel: T-Handle - Commercial - 304 Stainless Steel Part Number: BLP-159-0127-T-S4
15.88	12.70	14.73	19.05	304 Stainless Steel Shank / Aluminium Handle: Button Handle - Commercial - 304 Stainless Part Number: BLP-159-0127-BT-S4
15.88	12.70	14.73	19.05	Carbon Steel: Button Handle - Commercial - Carbon Steel Part Number: BLP-159-0127-BTC-C
15.88	12.70	14.73	19.05	Carbon Steel: T-Handle - Commercial - Carbon Steel Part Number: BLP-159-0127-TC-C
15.88 x 25.40 mm (0.63 x 1.00 in.)				
15.88	25.40	14.73	19.05	304 Stainless Steel: T-Handle - Commercial - 304 Stainless Steel Part Number: BLP-159-0254-T-S4
15.88	25.40	14.73	19.05	304 Stainless Steel Shank / Aluminium Handle: Button Handle - Commercial - 304 Stainless Part Number: BLP-159-0254-BT-S4
15.88	25.40	14.73	19.05	Carbon Steel: Button Handle - Commercial - Carbon Steel Part Number: BLP-159-0254-BTC-C
15.88	25.40	14.73	19.05	Carbon Steel: T-Handle - Commercial - Carbon Steel Part Number: BLP-159-0254-TC-C
15.88	25.40	16.51	19.00	304 Stainless Steel: Marine Style - Half Ring Part Number: BLP-159-0254-MHR-S4
15.88	25.40	16.51	19.00	304 Stainless Steel: Marine Style - Recessed Head Part Number: BLP-159-0254-MRE-S4
15.88	25.40	19.05	18.03	304 Stainless Steel: Keyring Style - 300 Grade Stainless Steel - Dual Ball Part Number: BLP-159-0254-K2-S4
15.88	25.40	19.05	18.03	316 Stainless Steel: Keyring Style - 316 Stainless Steel Part Number: BLP-159-0254-K1-S6
15.88 x 31.75 mm (0.63 x 1.25 in.)				
15.88	31.75	16.51	19.00	304 Stainless Steel: Marine Style - Half Ring Part Number: BLP-159-0318-MHR-S4
15.88	31.75	16.51	19.00	304 Stainless Steel: Marine Style - Recessed Head Part Number: BLP-159-0318-MRE-S4
15.88	31.75	19.05	18.03	304 Stainless Steel: Keyring Style - 300 Grade Stainless Steel - Dual Ball Part Number: BLP-159-0318-K2-S4
15.88	31.75	19.05	18.03	316 Stainless Steel: Keyring Style - 316 Stainless Steel Part Number: BLP-159-0318-K1-S6
15.88 x 38.10 mm (0.63 x 1.50 in.)				
15.88	38.10	14.73	19.05	17-4 PH Stainless: T-Handle - Industrial - Stainless Steel Part Number: BLP-159-0381-TI-S17
15.88	38.10	14.73	19.05	17-4 PH Stainless / Aluminium Handle: Button Handle - Stainless Steel Part Number: BLP-159-0381-BT-S17
15.88	38.10	14.73	19.05	304 Stainless Steel: T-Handle - Commercial - 304 Stainless Steel Part Number: BLP-159-0381-T-S4
15.88	38.10	14.73	19.05	304 Stainless Steel Shank / Aluminium Handle: Button Handle - Commercial - 304 Stainless Part Number: BLP-159-0381-BT-S4
15.88	38.10	14.73	19.05	Alloy Steel / Aluminium Handle: T-Handle - Industrial - Steel and Aluminium Part Number: BLP-159-0381-TI-AC
15.88	38.10	14.73	19.05	Carbon Steel: Button Handle - Commercial - Carbon Steel Part Number: BLP-159-0381-BTC-C
15.88	38.10	14.73	19.05	Carbon Steel: Button Handle - Steel Part Number: BLP-159-0381-BT-C
15.88	38.10	14.73	19.05	Carbon Steel: T-Handle - Commercial - Carbon Steel Part Number: BLP-159-0381-TC-C
15.88	38.10	16.51	19.00	17-4 PH Stainless: T-Handle - Stainless Steel - Heavy Duty Part Number: BLP-159-0381-THD-S17
15.88	38.10	16.51	19.00	304 Stainless Steel: Marine Style - Half Ring Part Number: BLP-159-0381-MHR-S4
15.88	38.10	16.51	19.00	304 Stainless Steel: Marine Style - Recessed Head Part Number: BLP-159-0381-MRE-S4

 Usually stocked or Short Delivery
 ** Available while stocks last **

 Long Delivery or Large Minimum Quantities
 Not in current production

Ball Lock Pins



Nominal Pin Dia. A (mm)	Grip Length (mm)	End Distance C (mm)	Open Ball Distance B (mm)	
15.88 x 38.10 mm (0.63 x 1.50 in.)				
15.88	38.10	19.05	18.03	304 Stainless Steel: Keyring Style - 300 Grade Stainless Steel - Dual Ball Part Number: BLP-159-0381-K2-S4
15.88	38.10	19.05	18.03	316 Stainless Steel: Keyring Style - 316 Stainless Steel Part Number: BLP-159-0381-K1-S6
15.88	38.10	19.05	18.03	Carbon Steel: Shoulder Type - T Handle Part Number: BLP-159-0381-TSH-C
15.88 x 44.45 mm (0.63 x 1.75 in.)				
15.88	44.45	16.51	19.00	304 Stainless Steel: Marine Style - Half Ring Part Number: BLP-159-0445-MHR-S4
15.88	44.45	16.51	19.00	304 Stainless Steel: Marine Style - Recessed Head Part Number: BLP-159-0445-MRE-S4
15.88	44.45	19.05	18.03	304 Stainless Steel: Keyring Style - 300 Grade Stainless Steel - Dual Ball Part Number: BLP-159-0445-K2-S4
15.88	44.45	19.05	18.03	316 Stainless Steel: Keyring Style - 316 Stainless Steel Part Number: BLP-159-0445-K1-S6
15.88 x 50.80 mm (0.63 x 2.00 in.)				
15.88	50.80	14.73	19.05	17-4 PH Stainless: T-Handle - Industrial - Stainless Steel Part Number: BLP-159-0058-TI-S17
15.88	50.80	14.73	19.05	17-4 PH Stainless / Aluminium Handle: Button Handle - Stainless Steel Part Number: BLP-159-0508-BT-S17
15.88	50.80	14.73	19.05	304 Stainless Steel: T-Handle - Commercial - 304 Stainless Steel Part Number: BLP-159-0508-T-S4
15.88	50.80	14.73	19.05	304 Stainless Steel Shank / Aluminium Handle: Button Handle - Commercial - 304 Stainless Part Number: BLP-159-0508-BT-S4
15.88	50.80	14.73	19.05	Carbon Steel: Button Handle - Commercial - Carbon Steel Part Number: BLP-159-0508-BTC-C
15.88	50.80	14.73	19.05	Carbon Steel: Button Handle - Steel Part Number: BLP-159-0508-BT-C
15.88	50.80	14.73	19.05	Carbon Steel: Ring Handle - Industrial - Steel Part Number: BLP-159-0508-RHI-C
15.88	50.80	14.73	19.05	Carbon Steel: T-Handle - Commercial - Carbon Steel Part Number: BLP-159-0508-TC-C
15.88	50.80	14.73	19.05	Carbon steel with aluminium handle, stainless ball and ring.: L-Handle - Industrial - Steel Part Number: BLP-159-0058-LI-C
15.88	50.80	16.51	19.00	17-4 PH Stainless: T-Handle - Stainless Steel - Heavy Duty Part Number: BLP-159-0508-THD-S17
15.88	50.80	16.51	19.00	304 Stainless Steel: Marine Style - Half Ring Part Number: BLP-159-0508-MHR-S4
15.88	50.80	16.51	19.00	304 Stainless Steel: Marine Style - Recessed Head Part Number: BLP-159-0508-MRE-S4
15.88	50.80	19.05	18.03	303 Stainless Steel: Keyring Style - 300 Grade Stainless Steel - Single Ball Part Number: BLP-159-0508-K1-S3
15.88	50.80	19.05	18.03	304 Stainless Steel: Keyring Style - 300 Grade Stainless Steel - Dual Ball Part Number: BLP-159-0508-K2-S4
15.88	50.80	19.05	18.03	316 Stainless Steel: Keyring Style - 316 Stainless Steel Part Number: BLP-159-0508-K1-S6
15.88	50.80	19.05	18.03	Carbon Steel: Keyring Style - Steel Part Number: BLP-159-0508-K1-C
15.88	50.80	19.05	18.03	Carbon Steel: Shoulder Type - T Handle Part Number: BLP-159-0508-TSH-C
15.88 x 63.50 mm (0.63 x 2.50 in.)				
15.88	63.50	14.73	19.05	17-4 PH Stainless: T-Handle - Industrial - Stainless Steel Part Number: BLP-159-0635-TI-S17
15.88	63.50	14.73	19.05	17-4 PH Stainless / Aluminium Handle: Button Handle - Stainless Steel Part Number: BLP-159-0635-BT-S17
15.88	63.50	14.73	19.05	304 Stainless Steel: T-Handle - Commercial - 304 Stainless Steel Part Number: BLP-159-0635-T-S4
15.88	63.50	14.73	19.05	304 Stainless Steel Shank / Aluminium Handle: Button Handle - Commercial - 304 Stainless Part Number: BLP-159-0635-BT-S4
15.88	63.50	14.73	19.05	Alloy Steel / Aluminium Handle: T-Handle - Industrial - Steel and Aluminium Part Number: BLP-159-0635-TI-AC



Usually stocked or Short Delivery
** Available while stocks last **

Long Delivery or Large Minimum Quantities
Not in current production

Ball Lock Pins

Nominal Pin Dia. A (mm)	Grip Length (mm)	End Distance C (mm)	Open Ball Distance B (mm)	
15.88 x 63.50 mm		<i>(0.63 x 2.50 in.)</i>		
15.88	63.50	14.73	19.05	Carbon Steel: Button Handle - Commercial - Carbon Steel Part Number: BLP-159-0635-BTC-C
15.88	63.50	14.73	19.05	Carbon Steel: Button Handle - Steel Part Number: BLP-159-0635-BT-C
15.88	63.50	14.73	19.05	Carbon Steel: Ring Handle - Industrial - Steel Part Number: BLP-159-0635-RHI-C
15.88	63.50	14.73	19.05	Carbon Steel: T-Handle - Commercial - Carbon Steel Part Number: BLP-159-0635-TC-C
15.88	63.50	14.73	19.05	Carbon steel with aluminium handle, stainless ball and ring.: L-Handle - Industrial - Steel Part Number: BLP-159-0635-LI-C
15.88	63.50	16.51	19.00	17-4 PH Stainless: T-Handle - Stainless Steel - Heavy Duty Part Number: BLP-159-0635-THD-S17
15.88	63.50	19.05	18.03	303 Stainless Steel: Keyring Style - 300 Grade Stainless Steel - Single Ball Part Number: BLP-159-0635-K1-S3
15.88	63.50	19.05	18.03	Carbon Steel: Keyring Style - Steel Part Number: BLP-159-0635-K1-C
15.88	63.50	19.05	18.03	Carbon Steel: Shoulder Type - Ring Handle Part Number: BLP-159-0635-RSH-C
15.88 x 76.20 mm		<i>(0.63 x 3.00 in.)</i>		
15.88	76.20	14.73	19.05	17-4 PH Stainless: L-Handle - Industrial - Stainless Steel Part Number: BLP-159-0762-LI-S17
15.88	76.20	14.73	19.05	17-4 PH Stainless: T-Handle - Industrial - Stainless Steel Part Number: BLP-159-0762-TI-S17
15.88	76.20	14.73	19.05	17-4 PH Stainless / Aluminium Handle: Button Handle - Stainless Steel Part Number: BLP-159-0762-BT-S17
15.88	76.20	14.73	19.05	304 Stainless Steel: T-Handle - Commercial - 304 Stainless Steel Part Number: BLP-159-0762-T-S4
15.88	76.20	14.73	19.05	304 Stainless Steel Shank / Aluminium Handle: Button Handle - Commercial - 304 Stainless Part Number: BLP-159-0762-BT-S4
15.88	76.20	14.73	19.05	Alloy Steel / Aluminium Handle: T-Handle - Industrial - Steel and Aluminium Part Number: BLP-159-0762-TI-AC
15.88	76.20	14.73	19.05	Carbon Steel: Button Handle - Commercial - Carbon Steel Part Number: BLP-159-0762-BTC-C
15.88	76.20	14.73	19.05	Carbon Steel: Button Handle - Steel Part Number: BLP-159-0760-BT-C
15.88	76.20	14.73	19.05	Carbon Steel: Ring Handle - Industrial - Steel Part Number: BLP-159-0762-RHI-C
15.88	76.20	14.73	19.05	Carbon Steel: T-Handle - Commercial - Carbon Steel Part Number: BLP-159-0762-TC-C
15.88	76.20	14.73	19.05	Carbon steel with aluminium handle, stainless ball and ring.: L-Handle - Industrial - Steel Part Number: BLP-159-0762-LI-C
15.88	76.20	16.51	19.00	17-4 PH Stainless: T-Handle - Stainless Steel - Heavy Duty Part Number: BLP-159-0762-THD-S17
15.88	76.20	16.51	19.00	304 Stainless Steel: Marine Style - Half Ring Part Number: BLP-159-0762-MHR-S4
15.88	76.20	16.51	19.00	304 Stainless Steel: Marine Style - Recessed Head Part Number: BLP-159-0762-MRE-S4
15.88	76.20	19.05	18.03	304 Stainless Steel: Keyring Style - 300 Grade Stainless Steel - Single Ball Part Number: BLP-159-0762-K1-S4
15.88	76.20	19.05	18.03	316 Stainless Steel: Keyring Style - 316 Stainless Steel Part Number: BLP-159-0762-K1-S6
15.88	76.20	19.05	18.03	Carbon Steel: Keyring Style - Steel Part Number: BLP-159-0762-K1-C
15.88 x 88.90 mm		<i>(0.63 x 3.50 in.)</i>		
15.88	88.90	14.73	19.05	17-4 PH Stainless: L-Handle - Industrial - Stainless Steel Part Number: BLP-159-0889-LI-S17
15.88	88.90	14.73	19.05	17-4 PH Stainless: T-Handle - Industrial - Stainless Steel Part Number: BLP-159-0889-TI-S17
15.88	88.90	14.73	19.05	17-4 PH Stainless / Aluminium Handle: Button Handle - Stainless Steel Part Number: BLP-159-0889-BT-S17

 Usually stocked or Short Delivery
 ** Available while stocks last **

 Long Delivery or Large Minimum Quantities
 Not in current production

Ball Lock Pins



Nominal Pin Dia. A (mm)	Grip Length (mm)	End Distance C (mm)	Open Ball Distance B (mm)	
15.88 x 88.90 mm (0.63 x 3.50 in.)				
15.88	88.90	14.73	19.05	304 Stainless Steel: T-Handle - Commercial - 304 Stainless Steel Part Number: BLP-159-0889-T-S4
15.88	88.90	14.73	19.05	304 Stainless Steel Shank / Aluminium Handle: Button Handle - Commercial - 304 Stainless Part Number: BLP-159-0889-BT-S4
15.88	88.90	14.73	19.05	Alloy Steel / Aluminium Handle: T-Handle - Industrial - Steel and Aluminium Part Number: BLP-159-0889-TI-AC
15.88	88.90	14.73	19.05	Carbon Steel: Button Handle - Commercial - Carbon Steel Part Number: BLP-159-0889-BTC-C
15.88	88.90	14.73	19.05	Carbon Steel: Button Handle - Steel Part Number: BLP-159-0889-BT-C
15.88	88.90	14.73	19.05	Carbon Steel: Ring Handle - Industrial - Steel Part Number: BLP-159-0889-RHI-C
15.88	88.90	14.73	19.05	Carbon Steel: T-Handle - Commercial - Carbon Steel Part Number: BLP-159-0889-TC-C
15.88	88.90	14.73	19.05	Carbon steel with aluminium handle, stainless ball and ring.: L-Handle - Industrial - Steel Part Number: BLP-159-0889-LI-C
15.88	88.90	16.51	19.00	17-4 PH Stainless: T-Handle - Stainless Steel - Heavy Duty Part Number: BLP-159-0889-THD-S17
15.88	88.90	19.05	18.03	Carbon Steel: Keyring Style - Steel Part Number: BLP-159-0889-K1-C
15.88 x 101.60 mm (0.63 x 4.00 in.)				
15.88	101.60	14.73	19.05	17-4 PH Stainless: T-Handle - Industrial - Stainless Steel Part Number: BLP-159-1016-TI-S17
15.88	101.60	14.73	19.05	17-4 PH Stainless / Aluminium Handle: Button Handle - Stainless Steel Part Number: BLP-159-1016-BT-S17
15.88	101.60	14.73	19.05	304 Stainless Steel: T-Handle - Commercial - 304 Stainless Steel Part Number: BLP-159-1016-T-S4
15.88	101.60	14.73	19.05	304 Stainless Steel Shank / Aluminium Handle: Button Handle - Commercial - 304 Stainless Part Number: BLP-159-1016-BT-S4
15.88	101.60	14.73	19.05	Alloy Steel / Aluminium Handle: T-Handle - Industrial - Steel and Aluminium Part Number: BLP-159-1016-TI-AC
15.88	101.60	14.73	19.05	Carbon Steel: Button Handle - Commercial - Carbon Steel Part Number: BLP-159-1016-BTC-C
15.88	101.60	14.73	19.05	Carbon Steel: Ring Handle - Industrial - Steel Part Number: BLP-159-1016-RHI-C
15.88	101.60	14.73	19.05	Carbon Steel: T-Handle - Commercial - Carbon Steel Part Number: BLP-159-1016-TC-C
15.88	101.60	14.73	19.05	Carbon steel with aluminium handle, stainless ball and ring.: L-Handle - Industrial - Steel Part Number: BLP-159-1016-LI-C
15.88	101.60	16.51	19.00	17-4 PH Stainless: T-Handle - Stainless Steel - Heavy Duty Part Number: BLP-159-1016-THD-S17
15.88	101.60	19.05	18.03	Carbon Steel: Keyring Style - Steel Part Number: BLP-159-1016-K1-C
15.88	101.60	19.05	18.03	Carbon Steel: Shoulder Type - T Handle Part Number: BLP-159-1016-TSH-C
15.88 x 114.30 mm (0.63 x 4.50 in.)				
15.88	114.30	14.73	19.05	17-4 PH Stainless: T-Handle - Industrial - Stainless Steel Part Number: BLP-159-1143-TI-S17
15.88	114.30	14.73	19.05	Alloy Steel / Aluminium Handle: T-Handle - Industrial - Steel and Aluminium Part Number: BLP-159-1143-TI-AC
15.88	114.30	14.73	19.05	Carbon Steel: Ring Handle - Industrial - Steel Part Number: BLP-159-1143-RHI-C
15.88	114.30	14.73	19.05	Carbon steel with aluminium handle, stainless ball and ring.: L-Handle - Industrial - Steel Part Number: BLP-159-1143-LI-C
15.88	114.30	16.51	19.00	17-4 PH Stainless: T-Handle - Stainless Steel - Heavy Duty Part Number: BLP-159-1143-THD-S17
15.88	114.30	19.05	18.03	303 Stainless Steel: Keyring Style - 300 Grade Stainless Steel - Single Ball Part Number: BLP-159-1143-K1-S3
15.88	114.30	19.05	18.03	Carbon Steel: Keyring Style - Steel Part Number: BLP-159-1143-K1-C



Usually stocked or Short Delivery
** Available while stocks last **

Long Delivery or Large Minimum Quantities
Not in current production

Ball Lock Pins

Nominal Pin Dia. A (mm)	Grip Length (mm)	End Distance C (mm)	Open Ball Distance B (mm)	
15.88 x 127.00 mm (0.63 x 5.00 in.)				
15.88	127.00	14.73	19.05	17-4 PH Stainless: T-Handle - Industrial - Stainless Steel Part Number: BLP-159-1270-TI-S17
15.88	127.00	14.73	19.05	17-4 PH Stainless / Aluminium Handle: Button Handle - Stainless Steel Part Number: BLP-159-1270-BT-S17
15.88	127.00	14.73	19.05	Alloy Steel / Aluminium Handle: T-Handle - Industrial - Steel and Aluminium Part Number: BLP-159-1270-TI-AC
15.88	127.00	14.73	19.05	Carbon Steel: Ring Handle - Industrial - Steel Part Number: BLP-159-1270-RHI-C
15.88	127.00	16.51	19.00	17-4 PH Stainless: T-Handle - Stainless Steel - Heavy Duty Part Number: BLP-159-1270-THD-S17
15.88	127.00	19.05	18.03	Carbon Steel: Keyring Style - Steel Part Number: BLP-159-1270-K1-C
15.88	127.00	19.05	18.03	Carbon Steel: Shoulder Type - Ring Handle Part Number: BLP-159-1270-RSH-C
15.88 x 139.70 mm (0.63 x 5.50 in.)				
15.88	139.70	14.73	19.05	17-4 PH Stainless: T-Handle - Industrial - Stainless Steel Part Number: BLP-159-1397-TI-S17
15.88	139.70	14.73	19.05	Alloy Steel / Aluminium Handle: T-Handle - Industrial - Steel and Aluminium Part Number: BLP-159-1397-TI-AC
15.88	139.70	14.73	19.05	Carbon steel with aluminium handle, stainless ball and ring.: L-Handle - Industrial - Steel Part Number: BLP-159-1397-LI-C
15.88 x 152.40 mm (0.63 x 6.00 in.)				
15.88	152.40	14.73	19.05	17-4 PH Stainless: L-Handle - Industrial - Stainless Steel Part Number: BLP-159-1524-LI-S17
15.88	152.40	14.73	19.05	17-4 PH Stainless: T-Handle - Industrial - Stainless Steel Part Number: BLP-159-1524-TI-S17
15.88	152.40	14.73	19.05	Alloy Steel / Aluminium Handle: T-Handle - Industrial - Steel and Aluminium Part Number: BLP-159-1524-TI-AC
15.88	152.40	14.73	19.05	Carbon steel with aluminium handle, stainless ball and ring.: L-Handle - Industrial - Steel Part Number: BLP-159-1524-LI-C
15.88	152.40	19.05	18.03	Carbon Steel: Keyring Style - Steel Part Number: BLP-159-1524-K1-C
16.00 x 50.00 mm (0.63 x 1.97 in.)				
16.00	50.00	14.00	19.00	17-4 PH Stainless / Aluminium Handle: T-Handle - Industrial - Stainless Steel and Aluminium Part Number: BLP-160-0500-TI-S17
16.00	50.00	14.00	19.00	Alloy Steel / Aluminium Handle: T-Handle - Industrial - Steel and Aluminium Part Number: BLP-160-0500-TI-AC
16.00 x 100.00 mm (0.63 x 3.94 in.)				
16.00	100.00	14.00	19.00	17-4 PH Stainless / Aluminium Handle: T-Handle - Industrial - Stainless Steel and Aluminium Part Number: BLP-160-1000-TI-S17
16.00	100.00	14.00	19.00	Alloy Steel / Aluminium Handle: T-Handle - Industrial - Steel and Aluminium Part Number: BLP-160-1000-TI-AC
19.05 x 25.40 mm (0.75 x 1.00 in.)				
19.05	25.40	17.96	22.53	Carbon Steel: Shackle Part Number: BLP-191-0254-SHK-C
19.05	25.40	19.81	22.53	304 Stainless Steel: Marine Style - Half Ring Part Number: BLP-191-0254-MHR-S4
19.05	25.40	19.81	22.53	304 Stainless Steel: Marine Style - Recessed Head Part Number: BLP-191-0254-MRE-S4
19.05 x 38.10 mm (0.75 x 1.50 in.)				
19.05	38.10	17.01	22.52	17-4 PH Stainless: T-Handle - Industrial - Stainless Steel Part Number: BLP-191-0381-TI-S17
19.05	38.10	17.01	22.52	17-4 PH Stainless / Aluminium Handle: Button Handle - Stainless Steel Part Number: BLP-191-0381-BT-S17
19.05	38.10	17.01	22.52	Alloy Steel / Aluminium Handle: T-Handle - Industrial - Steel and Aluminium Part Number: BLP-191-0381-TI-AC
19.05	38.10	17.01	22.52	Carbon steel with aluminium handle, stainless ball and ring.: L-Handle - Industrial - Steel Part Number: BLP-191-0381-LI-C

 Usually stocked or Short Delivery
 ** Available while stocks last **

 Long Delivery or Large Minimum Quantities
 Not in current production

Ball Lock Pins



Nominal Pin Dia. A (mm)	Grip Length (mm)	End Distance C (mm)	Open Ball Distance B (mm)	
19.05 x 38.10 mm (0.75 x 1.50 in.)				
19.05	38.10	19.81	22.53	17-4 PH Stainless: T-Handle - Stainless Steel - Heavy Duty Part Number: BLP-191-0381-THD-S17
19.05 x 50.80 mm (0.75 x 2.00 in.)				
19.05	50.80	17.01	22.52	17-4 PH Stainless: T-Handle - Industrial - Stainless Steel Part Number: BLP-191-0508-TI-S17
19.05	50.80	17.01	22.52	Alloy Steel / Aluminium Handle: T-Handle - Industrial - Steel and Aluminium Part Number: BLP-191-0508-TI-AC
19.05	50.80	17.01	22.52	Carbon Steel: Button Handle - Steel Part Number: BLP-191-0508-BT-C
19.05	50.80	17.01	22.52	Carbon Steel: Ring Handle - Industrial - Steel Part Number: BLP-191-0508-RHI-C
19.05	50.80	17.01	22.53	17-4 PH Stainless: L-Handle - Industrial - Stainless Steel Part Number: BLP-191-0508-LI-S17
19.05	50.80	19.81	22.53	304 Stainless Steel: Marine Style - Half Ring Part Number: BLP-191-0508-MHR-S4
19.05	50.80	19.81	22.53	304 Stainless Steel: Marine Style - Recessed Head Part Number: BLP-191-0508-MRE-S4
19.05	50.80	23.80	21.74	303 Stainless Steel: Keyring Style - 300 Grade Stainless Steel - Single Ball Part Number: BLP-191-0508-K1-S3
19.05	50.80	23.80	21.74	Carbon Steel: Keyring Style - Steel Part Number: BLP-191-0508-K1-C
19.05	50.80	23.80	21.74	Carbon Steel: Shoulder Type - Ring Handle Part Number: BLP-191-0508-RSH-C
19.05	50.80	23.80	21.74	Carbon Steel: Shoulder Type - T Handle Part Number: BLP-191-0508-TSH-C
19.05 x 63.50 mm (0.75 x 2.50 in.)				
19.05	63.50	17.01	22.52	17-4 PH Stainless: T-Handle - Industrial - Stainless Steel Part Number: BLP-191-0635-TI-S17
19.05	63.50	17.01	22.52	17-4 PH Stainless / Aluminium Handle: Button Handle - Stainless Steel Part Number: BLP-191-0635-BT-S17
19.05	63.50	17.01	22.52	Alloy Steel / Aluminium Handle: T-Handle - Industrial - Steel and Aluminium Part Number: BLP-191-0635-TI-AC
19.05	63.50	17.01	22.52	Carbon Steel: Button Handle - Steel Part Number: BLP-191-0635-BT-C
19.05	63.50	17.01	22.52	Carbon Steel: Ring Handle - Industrial - Steel Part Number: BLP-191-0635-RHI-C
19.05	63.50	17.01	22.52	Carbon steel with aluminium handle, stainless ball and ring.: L-Handle - Industrial - Steel Part Number: BLP-191-0635-LI-C
19.05	63.50	17.01	22.53	17-4 PH Stainless: L-Handle - Industrial - Stainless Steel Part Number: BLP-191-0635-LI-S17
19.05	63.50	19.81	22.53	17-4 PH Stainless: T-Handle - Stainless Steel - Heavy Duty Part Number: BLP-191-0635-THD-S17
19.05	63.50	23.80	21.74	303 Stainless Steel: Keyring Style - 300 Grade Stainless Steel - Single Ball Part Number: BLP-191-0635-K1-S3
19.05	63.50	23.80	21.74	Carbon Steel: Keyring Style - Steel Part Number: BLP-191-0635-K1-C
19.05	63.50	23.80	21.74	Carbon Steel: Shoulder Type - T Handle Part Number: BLP-191-0635-TSH-C
19.05 x 76.20 mm (0.75 x 3.00 in.)				
19.05	76.20	17.01	22.52	17-4 PH Stainless: T-Handle - Industrial - Stainless Steel Part Number: BLP-191-0762-TI-S17
19.05	76.20	17.01	22.52	Alloy Steel / Aluminium Handle: T-Handle - Industrial - Steel and Aluminium Part Number: BLP-191-0762-TI-AC
19.05	76.20	17.01	22.52	Carbon Steel: Button Handle - Steel Part Number: BLP-191-0760-BT-C
19.05	76.20	17.01	22.52	Carbon Steel: Ring Handle - Industrial - Steel Part Number: BLP-191-0762-RHI-C
19.05	76.20	17.01	22.52	Carbon steel with aluminium handle, stainless ball and ring.: L-Handle - Industrial - Steel Part Number: BLP-191-0762-LI-C
19.05	76.20	19.81	22.53	17-4 PH Stainless: T-Handle - Stainless Steel - Heavy Duty Part Number: BLP-191-0762-THD-S17



Usually stocked or Short Delivery
** Available while stocks last **

Long Delivery or Large Minimum Quantities
Not in current production

Ball Lock Pins



Nominal Pin Dia. A (mm)	Grip Length (mm)	End Distance C (mm)	Open Ball Distance B (mm)	
19.05 x 76.20 mm (0.75 x 3.00 in.)				
19.05	76.20	19.81	22.53	304 Stainless Steel: Marine Style - Half Ring Part Number: BLP-191-0762-MHR-S4
19.05	76.20	19.81	22.53	304 Stainless Steel: Marine Style - Recessed Head Part Number: BLP-191-0762-MRE-S4
19.05	76.20	23.80	21.74	303 Stainless Steel: Keyring Style - 300 Grade Stainless Steel - Single Ball Part Number: BLP-191-0762-K1-S3
19.05	76.20	23.80	21.74	Carbon Steel: Keyring Style - Steel Part Number: BLP-191-0762-K1-C
19.05	76.20	23.80	21.74	Carbon Steel: Shoulder Type - T Handle Part Number: BLP-191-0762-TSH-C
19.05 x 88.90 mm (0.75 x 3.50 in.)				
19.05	88.90	17.01	22.52	17-4 PH Stainless: T-Handle - Industrial - Stainless Steel Part Number: BLP-191-0889-TI-S17
19.05	88.90	17.01	22.52	17-4 PH Stainless / Aluminium Handle: Button Handle - Stainless Steel Part Number: BLP-191-0889-BT-S17
19.05	88.90	17.01	22.52	Alloy Steel / Aluminium Handle: T-Handle - Industrial - Steel and Aluminium Part Number: BLP-191-0889-TI-AC
19.05	88.90	17.01	22.52	Carbon Steel: Ring Handle - Industrial - Steel Part Number: BLP-191-0889-RHI-C
19.05	88.90	17.01	22.52	Carbon steel with aluminium handle, stainless ball and ring.: L-Handle - Industrial - Steel Part Number: BLP-191-0889-LI-C
19.05	88.90	23.80	21.74	303 Stainless Steel: Keyring Style - 300 Grade Stainless Steel - Single Ball Part Number: BLP-191-0889-K1-S3
19.05	88.90	23.80	21.74	Carbon Steel: Keyring Style - Steel Part Number: BLP-191-0889-K1-C
19.05	88.90	23.80	21.74	Carbon Steel: Shoulder Type - Ring Handle Part Number: BLP-191-0889-RSH-C
19.05	88.90	23.80	21.74	Carbon Steel: Shoulder Type - T Handle Part Number: BLP-191-0889-TSH-C
19.05 x 101.60 mm (0.75 x 4.00 in.)				
19.05	101.60	17.01	22.52	17-4 PH Stainless: T-Handle - Industrial - Stainless Steel Part Number: BLP-191-1016-TI-S17
19.05	101.60	17.01	22.52	17-4 PH Stainless / Aluminium Handle: Button Handle - Stainless Steel Part Number: BLP-191-1016-BT-S17
19.05	101.60	17.01	22.52	Alloy Steel / Aluminium Handle: T-Handle - Industrial - Steel and Aluminium Part Number: BLP-191-1016-TI-AC
19.05	101.60	17.01	22.52	Carbon Steel: Button Handle - Steel Part Number: BLP-191-1016-BT-C
19.05	101.60	17.01	22.52	Carbon steel with aluminium handle, stainless ball and ring.: L-Handle - Industrial - Steel Part Number: BLP-191-1016-LI-C
19.05	101.60	19.81	22.53	17-4 PH Stainless: T-Handle - Stainless Steel - Heavy Duty Part Number: BLP-191-1016-THD-S17
19.05	101.60	23.80	21.74	Carbon Steel: Keyring Style - Steel Part Number: BLP-191-1016-K1-C
19.05	101.60	23.80	21.74	Carbon Steel: Shoulder Type - Ring Handle Part Number: BLP-191-1016-RSH-C
19.05	101.60	23.80	21.74	Carbon Steel: Shoulder Type - T Handle Part Number: BLP-191-1016-TSH-C
19.05 x 114.30 mm (0.75 x 4.50 in.)				
19.05	114.30	17.01	22.52	Alloy Steel / Aluminium Handle: T-Handle - Industrial - Steel and Aluminium Part Number: BLP-191-1143-TI-AC
19.05	114.30	17.01	22.52	Carbon steel with aluminium handle, stainless ball and ring.: L-Handle - Industrial - Steel Part Number: BLP-191-1143-LI-C
19.05	114.30	19.81	22.53	17-4 PH Stainless: T-Handle - Stainless Steel - Heavy Duty Part Number: BLP-191-1143-THD-S17
19.05	114.30	23.80	21.74	303 Stainless Steel: Keyring Style - 300 Grade Stainless Steel - Single Ball Part Number: BLP-191-1143-K1-S3
19.05	114.30	23.80	21.74	Carbon Steel: Keyring Style - Steel Part Number: BLP-191-1143-K1-C



 Usually stocked or Short Delivery
 ** Available while stocks last **

 Long Delivery or Large Minimum Quantities
 Not in current production

Ball Lock Pins



Nominal Pin Dia. A (mm)	Grip Length (mm)	End Distance C (mm)	Open Ball Distance B (mm)	
19.05 x 127.00 mm (0.75 x 5.00 in.)				
19.05	127.00	17.01	22.52	17-4 PH Stainless: T-Handle - Industrial - Stainless Steel Part Number: BLP-191-1270-TI-S17
19.05	127.00	17.01	22.52	17-4 PH Stainless / Aluminium Handle: Button Handle - Stainless Steel Part Number: BLP-191-1270-BT-S17
19.05	127.00	17.01	22.52	Alloy Steel / Aluminium Handle: T-Handle - Industrial - Steel and Aluminium Part Number: BLP-191-1270-TI-AC
19.05	127.00	17.01	22.52	Carbon Steel: Button Handle - Steel Part Number: BLP-191-1270-BT-C
19.05	127.00	19.81	22.53	17-4 PH Stainless: T-Handle - Stainless Steel - Heavy Duty Part Number: BLP-191-1270-THD-S17
19.05	127.00	23.80	21.74	303 Stainless Steel: Keyring Style - 300 Grade Stainless Steel - Single Ball Part Number: BLP-191-1270-K1-S3
19.05	127.00	23.80	21.74	Carbon Steel: Keyring Style - Steel Part Number: BLP-191-1270-K1-C
19.05	127.00	23.80	21.74	Carbon Steel: Shoulder Type - Ring Handle Part Number: BLP-191-1270-RSH-C
19.05	127.00	23.80	21.74	Carbon Steel: Shoulder Type - T Handle Part Number: BLP-191-1270-TSH-C
19.05 x 139.70 mm (0.75 x 5.50 in.)				
19.05	139.70	17.01	22.52	17-4 PH Stainless: T-Handle - Industrial - Stainless Steel Part Number: BLP-191-1397-TI-S17
19.05	139.70	17.01	22.52	Alloy Steel / Aluminium Handle: T-Handle - Industrial - Steel and Aluminium Part Number: BLP-191-1397-TI-AC
19.05	139.70	17.01	22.52	Carbon steel with aluminium handle, stainless ball and ring.: L-Handle - Industrial - Steel Part Number: BLP-191-1397-LI-C
19.05 x 152.40 mm (0.75 x 6.00 in.)				
19.05	152.40	17.01	22.52	17-4 PH Stainless: T-Handle - Industrial - Stainless Steel Part Number: BLP-191-1524-TI-S17
19.05	152.40	17.01	22.52	Alloy Steel / Aluminium Handle: T-Handle - Industrial - Steel and Aluminium Part Number: BLP-191-1524-TI-AC
19.05	152.40	17.01	22.52	Carbon Steel: Ring Handle - Industrial - Steel Part Number: BLP-191-1524-RHI-C
19.05	152.40	23.80	21.74	Carbon Steel: Keyring Style - Steel Part Number: BLP-191-1524-K1-C
19.05 x 165.10 mm (0.75 x 6.50 in.)				
19.05	165.10	23.80	21.74	303 Stainless Steel: Keyring Style - 300 Grade Stainless Steel - Single Ball Part Number: BLP-191-1651-K1-S3
19.05	165.10	23.80	21.74	Carbon Steel: Keyring Style - Steel Part Number: BLP-191-1651-K1-C
19.05 x 177.80 mm (0.75 x 7.00 in.)				
19.05	177.80	23.80	21.74	303 Stainless Steel: Keyring Style - 300 Grade Stainless Steel - Single Ball Part Number: BLP-191-1778-K1-S3
19.05	177.80	23.80	21.74	Carbon Steel: Keyring Style - Steel Part Number: BLP-191-1778-K1-C
19.05 x 203.20 mm (0.75 x 8.00 in.)				
19.05	203.20	23.80	21.74	Carbon Steel: Keyring Style - Steel Part Number: BLP-191-2032-K1-C
20.00 x 25.00 mm (0.79 x 0.98 in.)				
20.00	25.00	17.00	24.08	17-4 PH Stainless / Aluminium Handle: T-Handle - Industrial - Stainless Steel and Aluminium Part Number: BLP-200-0250-TI-S17
20.00 x 50.00 mm (0.79 x 1.97 in.)				
20.00	50.00	17.00	24.08	17-4 PH Stainless / Aluminium Handle: T-Handle - Industrial - Stainless Steel and Aluminium Part Number: BLP-200-0500-TI-S17
20.00 x 75.00 mm (0.79 x 2.95 in.)				
20.00	75.00	17.00	24.08	17-4 PH Stainless / Aluminium Handle: T-Handle - Industrial - Stainless Steel and Aluminium Part Number: BLP-200-0750-TI-S17



 Usually stocked or Short Delivery
 ** Available while stocks last **

 Long Delivery or Large Minimum Quantities
 Not in current production

Ball Lock Pins



Nominal Pin Dia. A (mm)	Grip Length (mm)	End Distance C (mm)	Open Ball Distance B (mm)	
22.00 x 100.00 mm (0.79 x 3.94 in.)				
20.00	100.00	17.00	24.08	17-4 PH Stainless / Aluminium Handle: T-Handle - Industrial - Stainless Steel and Aluminium Part Number: BLP-200-1000-TI-S17
22.23 x 76.20 mm (0.88 x 3.00 in.)				
22.23	76.20	19.30	26.56	Alloy Steel / Aluminium Handle: T-Handle - Industrial - Steel and Aluminium Part Number: BLP-222-0762-TI-AC
22.23	76.20	19.30	26.56	Carbon Steel: Ring Handle - Industrial - Steel Part Number: BLP-222-0762-RHI-C
22.23	76.20	19.30	26.56	Carbon steel with aluminium handle, stainless ball and ring.: L-Handle - Industrial - Steel Part Number: BLP-222-0762-LI-C
22.23 x 101.60 mm (0.88 x 4.00 in.)				
22.23	101.60	19.30	26.56	Carbon Steel: Ring Handle - Industrial - Steel Part Number: BLP-222-1016-RHI-C
22.23	101.60	19.30	26.56	Carbon steel with aluminium handle, stainless ball and ring.: L-Handle - Industrial - Steel Part Number: BLP-222-1016-LI-C
22.23 x 152.40 mm (0.88 x 6.00 in.)				
22.23	152.40	19.30	26.56	Alloy Steel / Aluminium Handle: T-Handle - Industrial - Steel and Aluminium Part Number: BLP-222-1524-TI-AC
22.23	152.40	19.30	26.56	Carbon steel with aluminium handle, stainless ball and ring.: L-Handle - Industrial - Steel Part Number: BLP-222-1524-LI-C
25.40 x 50.80 mm (1.00 x 2.00 in.)				
25.40	50.80	22.60	30.96	17-4 PH Stainless: T-Handle - Industrial - Stainless Steel Part Number: BLP-254-0508-TI-S17
25.40	50.80	22.60	30.96	17-4 PH Stainless / Aluminium Handle: Button Handle - Stainless Steel Part Number: BLP-254-0508-BT-S17
25.40	50.80	22.60	30.96	Alloy Steel / Aluminium Handle: T-Handle - Industrial - Steel and Aluminium Part Number: BLP-254-0508-TI-AC
25.40	50.80	22.60	30.96	Carbon Steel: Ring Handle - Industrial - Steel Part Number: BLP-254-0508-RHI-C
25.40	50.80	25.40	30.91	17-4 PH Stainless: T-Handle - Stainless Steel - Heavy Duty Part Number: BLP-254-0508-THD-S17
25.40	50.80	31.75	28.96	303 Stainless Steel: Keyring Style - 300 Grade Stainless Steel - Single Ball Part Number: BLP-254-0508-K1-S3
25.40	50.80	31.75	28.96	Carbon Steel: Keyring Style - Steel Part Number: BLP-254-0508-K1-C
25.40 x 63.50 mm (1.00 x 2.50 in.)				
25.40	63.50	22.60	30.96	17-4 PH Stainless: L-Handle - Industrial - Stainless Steel Part Number: BLP-254-0635-LI-S17
25.40	63.50	22.60	30.96	17-4 PH Stainless: T-Handle - Industrial - Stainless Steel Part Number: BLP-254-0635-TI-S17
25.40	63.50	22.60	30.96	17-4 PH Stainless / Aluminium Handle: Button Handle - Stainless Steel Part Number: BLP-254-0635-BT-S17
25.40	63.50	22.60	30.96	Alloy Steel / Aluminium Handle: T-Handle - Industrial - Steel and Aluminium Part Number: BLP-254-0635-TI-AC
25.40	63.50	22.60	30.96	Carbon steel with aluminium handle, stainless ball and ring.: L-Handle - Industrial - Steel Part Number: BLP-254-0635-LI-C
25.40	63.50	31.75	28.96	Carbon Steel: Keyring Style - Steel Part Number: BLP-254-0635-K1-C
25.40	63.50	31.75	28.96	Carbon Steel: Shoulder Type - Ring Handle Part Number: BLP-254-0635-RSH-C
25.40 x 76.20 mm (1.00 x 3.00 in.)				
25.40	76.20	22.60	30.96	17-4 PH Stainless: T-Handle - Industrial - Stainless Steel Part Number: BLP-254-0762-TI-S17
25.40	76.20	22.60	30.96	17-4 PH Stainless / Aluminium Handle: Button Handle - Stainless Steel Part Number: BLP-254-0762-BT-S17
25.40	76.20	22.60	30.96	Alloy Steel / Aluminium Handle: T-Handle - Industrial - Steel and Aluminium Part Number: BLP-254-0762-TI-AC
25.40	76.20	25.40	30.91	17-4 PH Stainless: T-Handle - Stainless Steel - Heavy Duty Part Number: BLP-254-0762-THD-S17



 Usually stocked or Short Delivery
 ** Available while stocks last **

 Long Delivery or Large Minimum Quantities
 Not in current production

Ball Lock Pins



Nominal Pin Dia. A (mm)	Grip Length (mm)	End Distance C (mm)	Open Ball Distance B (mm)	
25.40 x 76.20 mm (1.00 x 3.00 in.)				
25.40	76.20	31.75	28.96	303 Stainless Steel: Keyring Style - 300 Grade Stainless Steel - Single Ball Part Number: BLP-254-0762-K1-S3
25.40	76.20	31.75	28.96	Carbon Steel: Keyring Style - Steel Part Number: BLP-254-0762-K1-C
25.40	76.20	31.75	28.96	Carbon Steel: Shoulder Type - Ring Handle Part Number: BLP-254-0762-RSH-C
25.40	76.20	31.75	28.96	Carbon Steel: Shoulder Type - T Handle Part Number: BLP-254-0762-TSH-C
25.40 x 88.90 mm (1.00 x 3.50 in.)				
25.40	88.90	22.60	30.96	Alloy Steel / Aluminium Handle: T-Handle - Industrial - Steel and Aluminium Part Number: BLP-254-0889-TI-AC
25.40	88.90	22.60	30.96	Carbon steel with aluminium handle, stainless ball and ring.: L-Handle - Industrial - Steel Part Number: BLP-254-0889-LI-C
25.40	88.90	31.75	28.96	303 Stainless Steel: Keyring Style - 300 Grade Stainless Steel - Single Ball Part Number: BLP-254-0889-K1-S3
25.40	88.90	31.75	28.96	Carbon Steel: Keyring Style - Steel Part Number: BLP-254-0889-K1-C
25.40 x 101.60 mm (1.00 x 4.00 in.)				
25.40	101.60	22.60	30.96	17-4 PH Stainless: T-Handle - Industrial - Stainless Steel Part Number: BLP-254-1016-TI-S17
25.40	101.60	22.60	30.96	Alloy Steel / Aluminium Handle: T-Handle - Industrial - Steel and Aluminium Part Number: BLP-254-1016-TI-AC
25.40	101.60	22.60	30.96	Carbon Steel: Ring Handle - Industrial - Steel Part Number: BLP-254-1016-RHI-C
25.40	101.60	22.60	30.96	Carbon steel with aluminium handle, stainless ball and ring.: L-Handle - Industrial - Steel Part Number: BLP-254-1016-LI-C
25.40	101.60	25.40	30.91	17-4 PH Stainless: T-Handle - Stainless Steel - Heavy Duty Part Number: BLP-254-1016-THD-S17
25.40	101.60	31.75	28.96	303 Stainless Steel: Keyring Style - 300 Grade Stainless Steel - Single Ball Part Number: BLP-254-1016-K1-S3
25.40	101.60	31.75	28.96	Carbon Steel: Keyring Style - Steel Part Number: BLP-254-1016-K1-C
25.40	101.60	31.75	28.96	Carbon Steel: Shoulder Type - Ring Handle Part Number: BLP-254-1016-RSH-C
25.40	101.60	31.75	28.96	Carbon Steel: Shoulder Type - T Handle Part Number: BLP-254-1016-TSH-C
25.40 x 114.30 mm (1.00 x 4.50 in.)				
25.40	114.30	22.60	30.96	Alloy Steel / Aluminium Handle: T-Handle - Industrial - Steel and Aluminium Part Number: BLP-254-1143-TI-AC
25.40	114.30	22.60	30.96	Carbon steel with aluminium handle, stainless ball and ring.: L-Handle - Industrial - Steel Part Number: BLP-254-1143-LI-C
25.40	114.30	31.75	28.96	Carbon Steel: Keyring Style - Steel Part Number: BLP-254-1143-K1-C
25.40 x 127.00 mm (1.00 x 5.00 in.)				
25.40	127.00	22.60	30.96	17-4 PH Stainless: T-Handle - Industrial - Stainless Steel Part Number: BLP-254-1270-TI-S17
25.40	127.00	22.60	30.96	17-4 PH Stainless / Aluminium Handle: Button Handle - Stainless Steel Part Number: BLP-254-1270-BT-S17
25.40	127.00	22.60	30.96	Alloy Steel / Aluminium Handle: T-Handle - Industrial - Steel and Aluminium Part Number: BLP-254-1270-TI-AC
25.40	127.00	25.40	30.91	17-4 PH Stainless: T-Handle - Stainless Steel - Heavy Duty Part Number: BLP-254-1270-THD-S17
25.40	127.00	31.75	28.96	Carbon Steel: Keyring Style - Steel Part Number: BLP-254-1270-K1-C
25.40	127.00	31.75	28.96	Carbon Steel: Shoulder Type - T Handle Part Number: BLP-254-1270-TSH-C
25.40 x 139.70 mm (1.00 x 5.50 in.)				
25.40	139.70	22.60	30.96	17-4 PH Stainless: T-Handle - Industrial - Stainless Steel Part Number: BLP-254-1397-TI-S17



 Usually stocked or Short Delivery
 ** Available while stocks last **

 Long Delivery or Large Minimum Quantities
 Not in current production

Ball Lock Pins



Nominal Pin Dia. A (mm)	Grip Length (mm)	End Distance C (mm)	Open Ball Distance B (mm)	
25.40 x 139.70 mm (1.00 x 5.50 in.)				
25.40	139.70	22.60	30.96	Carbon steel with aluminium handle, stainless ball and ring.: L-Handle - Industrial - Steel Part Number: BLP-254-1397-LI-C
25.40	139.70	31.75	28.96	Carbon Steel: Keyring Style - Steel Part Number: BLP-254-1397-K1-C
25.40 x 152.40 mm (1.00 x 6.00 in.)				
25.40	152.40	22.60	30.96	17-4 PH Stainless: T-Handle - Industrial - Stainless Steel Part Number: BLP-254-1524-TI-S17
25.40	152.40	22.60	30.96	17-4 PH Stainless / Aluminium Handle: Button Handle - Stainless Steel Part Number: BLP-254-1524-BT-S17
25.40	152.40	22.60	30.96	Alloy Steel / Aluminium Handle: T-Handle - Industrial - Steel and Aluminium Part Number: BLP-254-1524-TI-AC
25.40	152.40	22.60	30.96	Carbon Steel: Ring Handle - Industrial - Steel Part Number: BLP-254-1524-RHI-C
25.40	152.40	25.40	30.91	17-4 PH Stainless: T-Handle - Stainless Steel - Heavy Duty Part Number: BLP-254-1524-THD-S17
25.40	152.40	31.75	28.96	Carbon Steel: Shoulder Type - T Handle Part Number: BLP-254-1524-TSH-C
25.40 x 177.80 mm (1.00 x 7.00 in.)				
25.40	177.80	22.60	30.96	17-4 PH Stainless: T-Handle - Industrial - Stainless Steel Part Number: BLP-254-1778-TI-S17
25.40	177.80	22.60	30.96	Carbon steel with aluminium handle, stainless ball and ring.: L-Handle - Industrial - Steel Part Number: BLP-254-1778-LI-C
25.40	177.80	31.75	28.96	Carbon Steel: Keyring Style - Steel Part Number: BLP-254-1778-K1-C
25.40 x 203.20 mm (1.00 x 8.00 in.)				
25.40	203.20	31.75	28.96	303 Stainless Steel: Keyring Style - 300 Grade Stainless Steel - Single Ball Part Number: BLP-254-2032-K1-S3
25.40	203.20	31.75	28.96	Carbon Steel: Keyring Style - Steel Part Number: BLP-254-2032-K1-C



 Usually stocked or Short Delivery
 ** Available while stocks last **

 Long Delivery or Large Minimum Quantities
 Not in current production

Receptacles

Suits Pin Dia. (mm)	Style	Tube Dia. (mm)	Flange Thickness (mm)	
6.35 mm (0.25 inch.)				
6.35	D	9.53	1.52	Part Number: BLP-064-D-REC-S3
6.35	B	9.53	1.52	Part Number: BLP-064-B-REC-S3
6.35	A	9.53	1.52	Part Number: BLP-064-A-REC-S3
6.35	C	9.53	1.52	Part Number: BLP-064-C-REC-S3
7.94 mm (0.31 inch.)				
7.94	D	11.91	1.52	Part Number: BLP-079-D-REC-S3
7.94	C	11.91	1.52	Part Number: BLP-079-C-REC-S3
7.94	B	11.91	1.52	Part Number: BLP-079-B-REC-S3
7.94	A	11.91	1.52	Part Number: BLP-079-A-REC-S3
9.53 mm (0.38 inch.)				
9.53	D	14.28	1.52	Part Number: BLP-095-D-REC-S3
9.53	B	14.28	1.52	Part Number: BLP-095-B-REC-S3
9.53	A	14.28	1.52	Part Number: BLP-095-A-REC-S3
9.53	C	14.28	1.52	Part Number: BLP-095-C-REC-S3
12.70 mm (0.50 inch.)				
12.70	D	19.05	2.54	Part Number: BLP-127-D-REC-S3
12.70	A	19.05	2.54	Part Number: BLP-127-A-REC-S3
12.70	C	19.05	2.54	Part Number: BLP-127-C-REC-S3

 Usually stocked or Short Delivery
 ** Available while stocks last **

 Long Delivery or Large Minimum Quantities
 Not in current production

Tips

- Stainless steel models use a variety of stainless steel types in their construction. The pin material listed is for the main pin shank only. Stainless buttons, handles and springs are usually 300 grade stainless whilst the balls are usually 440C grade stainless.
- 17-4 PH Stainless Pins are heat treated to Rockwell C 40 Minimum.
- Button handle type pins require the button to be depressed before the balls retract into the shank allowing the pin to be removed.
- Non button type are removed by applying sufficient pull force.



Distributed By

Miniature Bearings Australia
<http://www.minibearings.com.au>
sales@minibearings.com.au

Resellers: Please place your contact sticker over our details

Avoid verbal communication

We sell an extensive range of products with varying amounts of technical data. Please assist us to provide you with accurate information by placing your orders and enquiries online or by e-mail.

Ball Lock Pins